

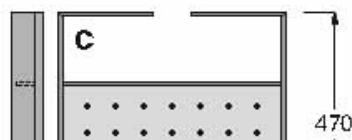

Name Colonne attrezzate_Colonna con anta a battente CONVOY

Year

Description Specific 600 mm tall units with hinged doors are available to be equipped with Convoy mechanism. The pull-out structure is made of aluminium and black metal with 5 shelves, which should be fitted with wood trays, to be ordered separately. The mechanism is equipped with soft close device. The mechanism is connected to the cabinet door and is pushed out every time the door opens. The trays for accessorizing the shelves are made of black-stained ash wood and include: bottom in felt lining, tray for glasses/small cups, tray for pots/pans, larder tray with dividers, tray for bottles, tray for dishes with handles.

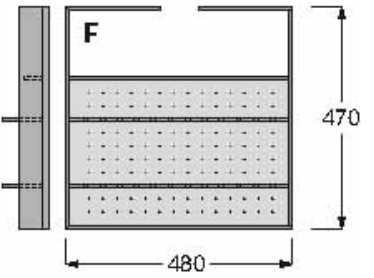
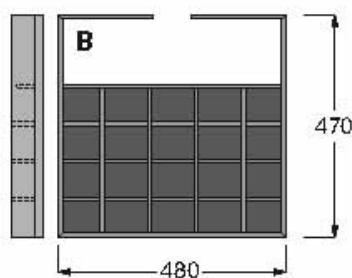
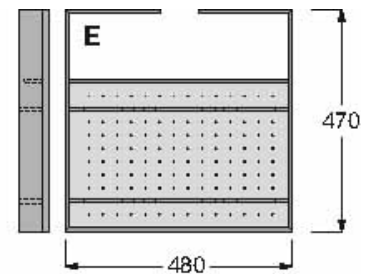
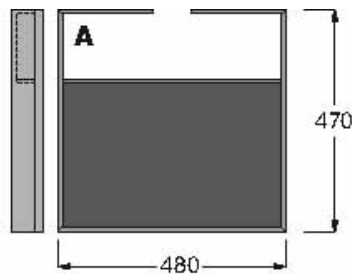
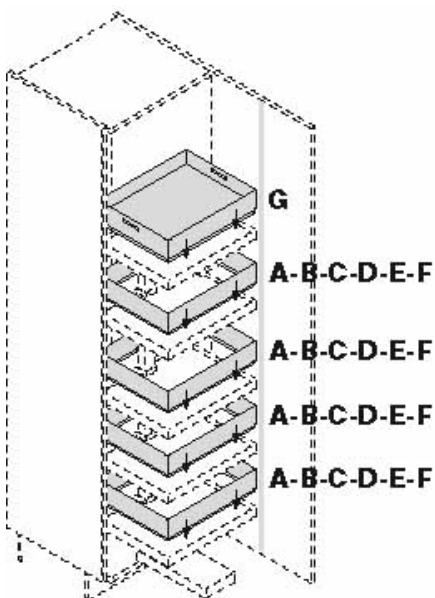
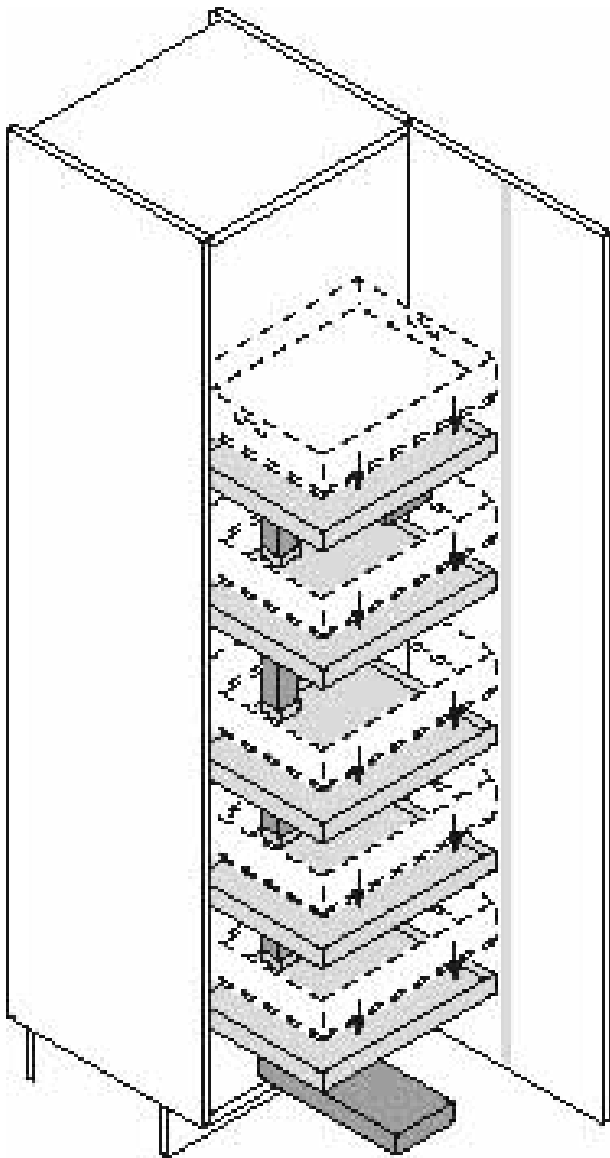

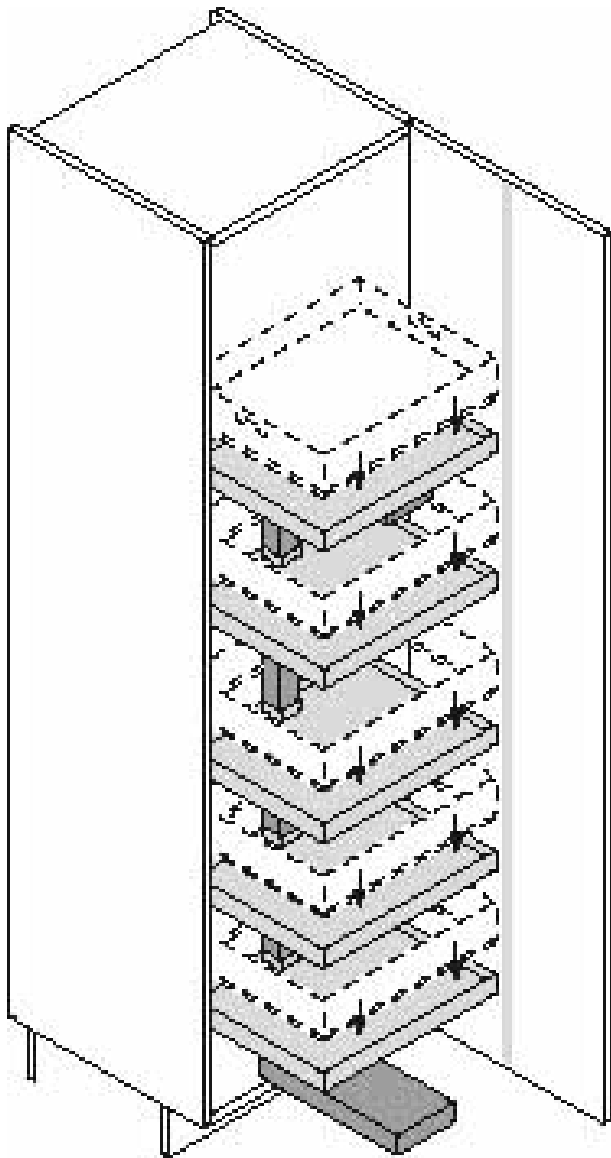

Boffi S.p.a.

Via Oberdan, 70

20823 Lentate sul Seveso (MB) - Italy

p.iva IT 02642250969

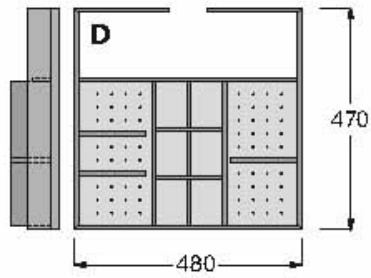
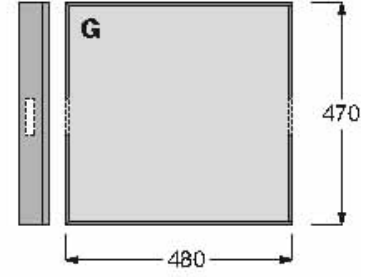
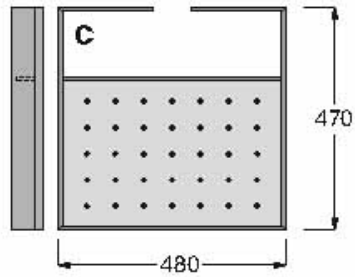
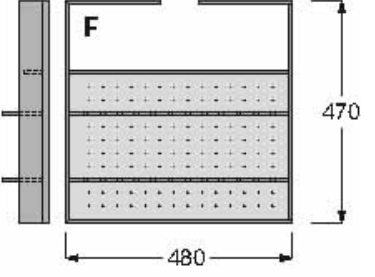
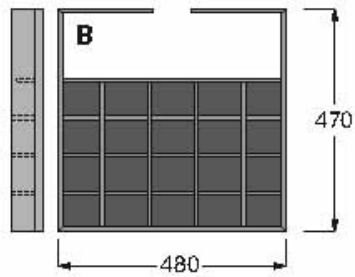
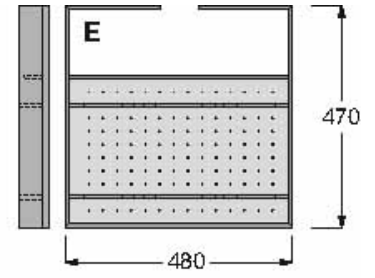
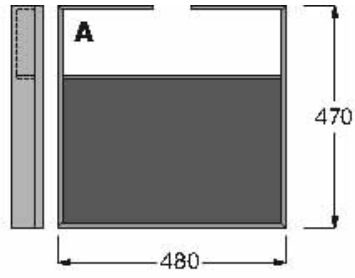
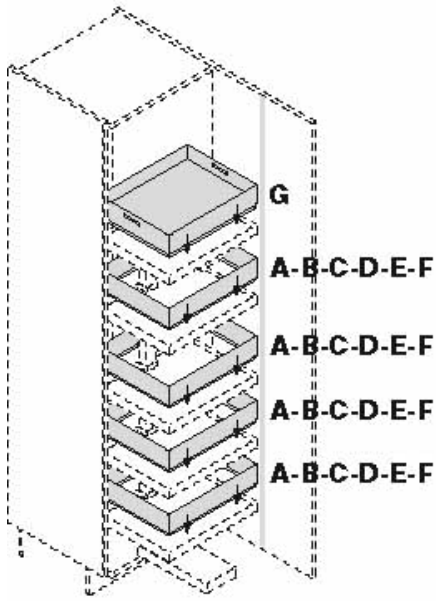

Boffi S.p.a.

Via Oberdan, 70

20823 Lentate sul Seveso (MB) - Italy

p.iva IT 02642250969



Name Colonne attrezzate_Colonna ad angolo lineare FLY MOON

Year

Description Pull-out system for variable corner units (base or tall units) with hinged door where the shelves can be pulled-out totally. The shelves have a bottom in melamine wood particle board panel and black trims, with chrome-plated round wire rail. The mechanism for the base units has two shelves, the one for the tall units has four shelves.

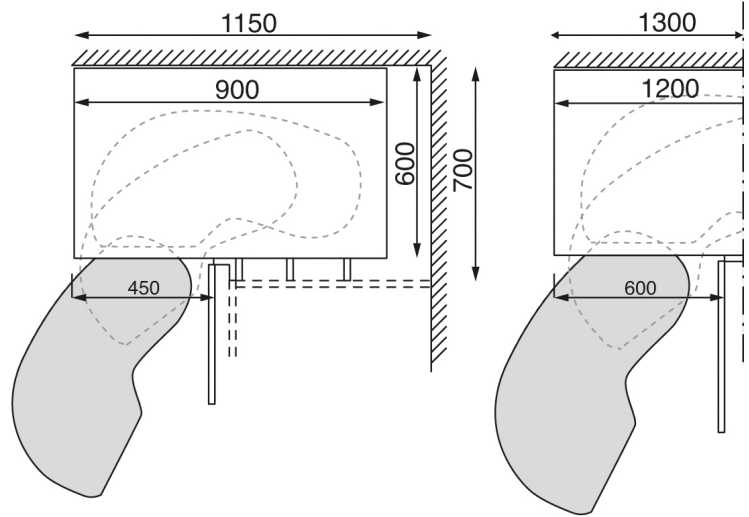
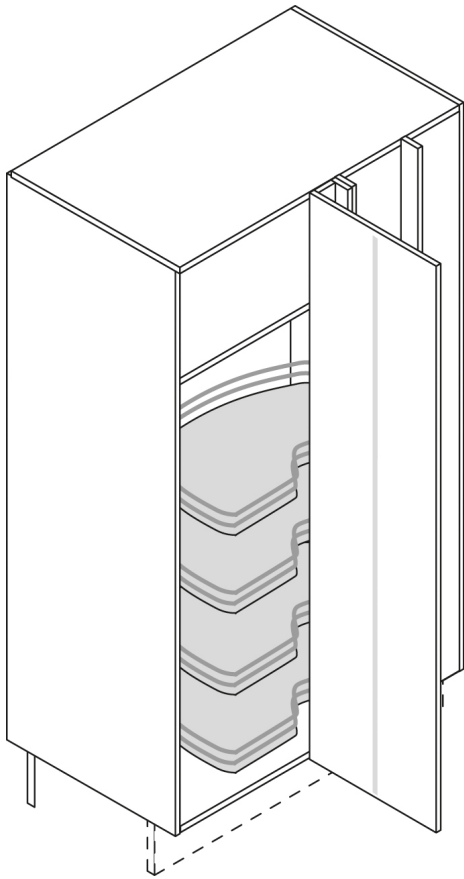

Boffi S.p.a.

Via Oberdan, 70

20823 Lentate sul Seveso (MB) - Italy

p.iva IT 02642250969



Name	Colonne attrezzate_Cassettiera sospesa
Year	
Description	HIDE - Short suspended drawer unit with pull-out top, for STORAGE module with side-recessing door. - 2 drawers
Technical Details	<p>Pull-out drawer and upper top: flap opening for drawer. The opening is allowed thanks to the lateral grip of front panels. Drawer unit H 286 mm + top H 12 mm. + raised part H 56 mm.</p> <p>L. 503/653/734/1034 - P. 674 / H. 355 mm.</p>
Materials	Structural, front and upper panels in melamine, same finish as carcass. Lateral spacers and upper front panel in aluminium, MATT BLACK painted.

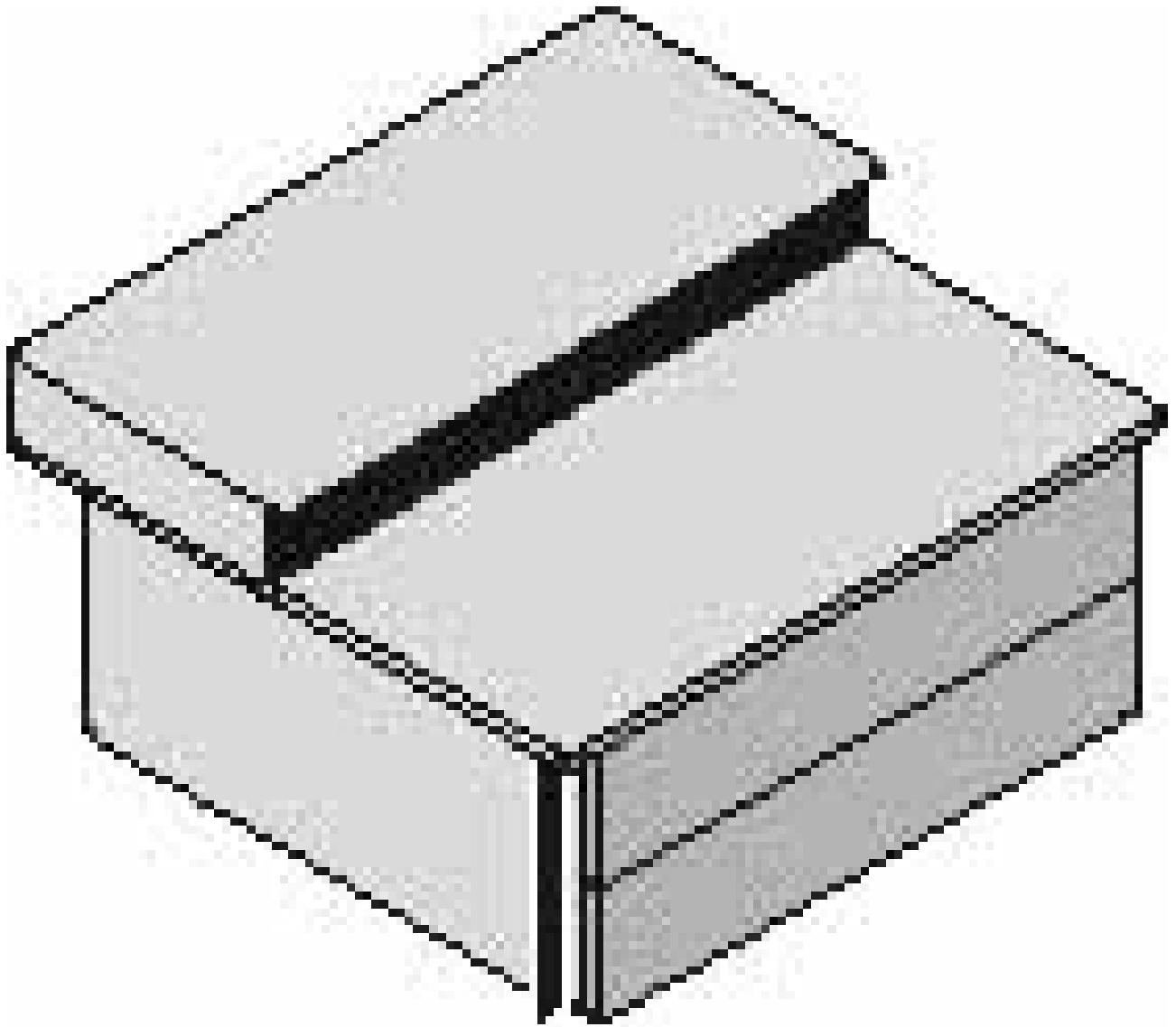

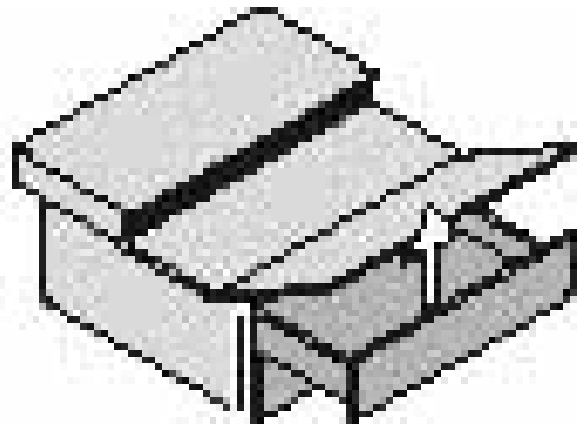
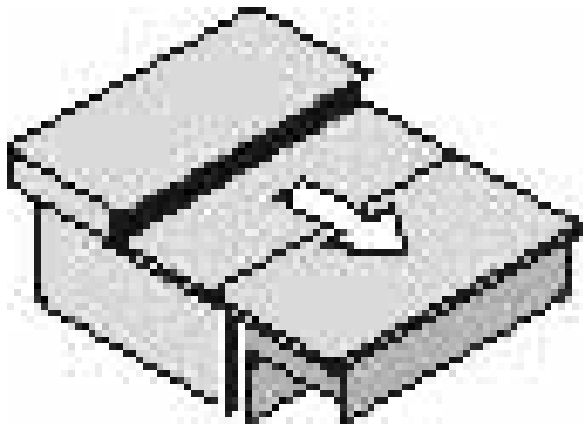

Boffi S.p.a.

Via Oberdan, 70

20823 Lentate sul Seveso (MB) - Italy

p.iva IT 02642250969