

B14

Design Norbert Wangen

Sistema modulare di contenitori base sospesi ad uso intermedio o terminale, senza maniglia, con profilo fascia maniglia sottopiano.

L'impugnatura per l'apertura dell'anta è ottenuta grazie allo smusso superiore dell'anta stessa in combinazione con la fascia maniglia sottopiano e lo smusso perimetrale del piano.

Piano (1)

Piano caratterizzato da smussi inclinati a vista su uno o più lati, in funzione del progetto.

Testata laterale inclinata a 35°. (Smusso inferiore). (1a)

SPESSORE: 50 mm.

PROFONDITÀ: 505 mm.

LAVABI COMPATIBILI: soprapiano da appoggio, soprapiano da incasso e sottopiano da incasso.

Contenitore (2)

Realizzato in pannelli di particelle di legno di spessore 19 mm, idrofughi, a basso contenuto di formaldeide (certificato classe E1, CARB P2 / TSCA Title VI) nobilitato con carte ad alta grammatura trattate con resine melamminiche. Bordo anteriore e posteriore in ABS in tinta.

ALTEZZA FIANCO: 300 - 635 mm (entrambe compatibili con lavabi Boffi soprapiano da incasso / sottopiano da incasso / filopiano stampato).

PROFONDITÀ FIANCO: 470 mm.

PROFONDITÀ CON FRONTALE: 495 mm.

LARGHEZZA MODULO: 300 - 450 - 600 - 900 - 1200 mm.

Ante e frontali (3)

Realizzate in finitura, spessore 23 mm, con smusso superiore (tipo anta BN).

Su frontali di basi ad uso terminale e pannelli terminali smusso aggiuntivo laterale verticale.

Fascia maniglia sottopiano (4)

Realizzata in alluminio verniciato, è prevista tra piano e ante lungo tutti i lati smussati del piano.

Uso longitudinale. (4a)

Uso laterale. (4b)

FINITURE: bianco - nero.

Cassetti (5)

Sistema LEGRABOX, con spondine laterali e posteriore in metallo verniciato in colore nero opaco.

Fondo in nobilitato nero.

Frontale cassetti interni in nobilitato finitura contenitore.

Pannello terminale (6)

Realizzato in finitura, spessore 23 mm.

Smusso su bordo frontale e superiore.

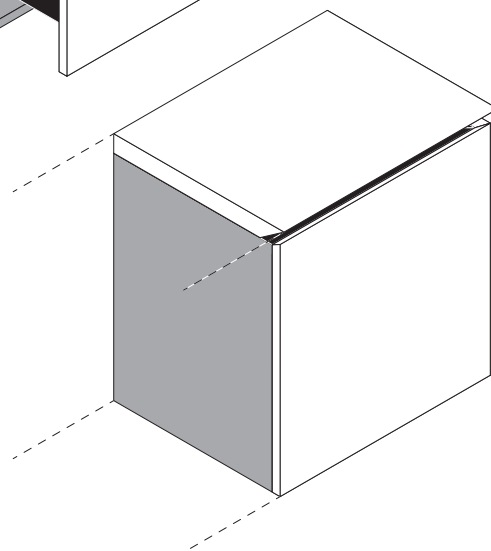
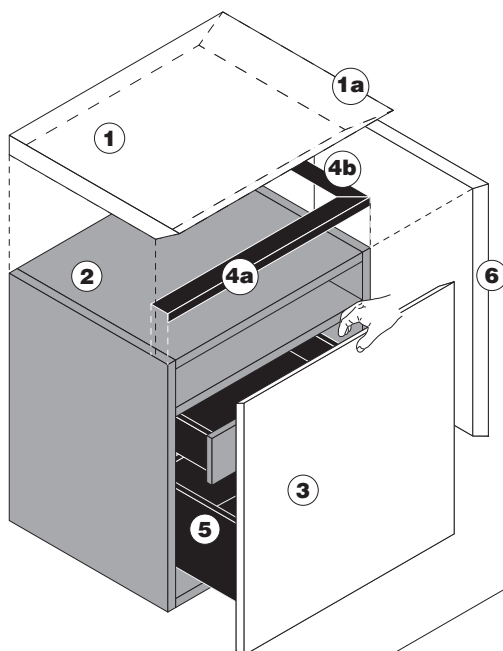



606
Olmo (effetto
poro aperto)

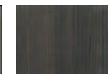

610
Larice
termico
(effetto poro
aperto)



608
Rovere grafite
(effetto poro
aperto)

FINITURA
FRONTALI

COLORI / ESSENZE

EASYLAK+

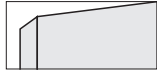

506
Bianco
Cortina



507
Grigio Leeds

SILCOLAK

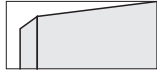

521
Bianco
Siberia



523
Ostrica



524
Grigio Luton



525
Ghiaia



526
Fieno



527
Corda



528
Limo



529
Ardesia



530
Abisso



531
Nero Intenso

ECOLAK

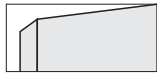

510
Bianco artico



129
Magnolia



513
Nuvola



024
Ciottolo



512
Avena



025
Ecrù



023
Fango



515
Basalto



517
Carbone



027
Nero

LASERMAT

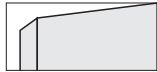

183
Bianco Kos



178
Bianco Malè



179
Beige Luxor



187
Beige Arizona



184
Grigio Efeso



202
Grigio Antrim



181
Grigio Londra



185
Grigio Bromo



203
Blu Fes



188
Verde
Comodoro



186
Cacao
Orinoco



182
Nero Ingo



189
Rosso Jaipur

LEGNO

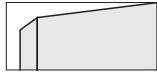

049
Rovere



033
Rovere
cenere



076
Rovere grafite



334
Ecowood Xilo
2.0 Planked
Sand (18.22)



335
Ecowood Xilo
2.0 Planked
Grey (18.23)



333
Ecowood Xilo
2.0 Striped
Black (18.04)

POLIESTERE

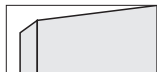

003
Bianco



129
Magnolia



024
Ciottolo



005
Grigio RAL
7038



063
Sabbia



113
Verde caligo



107
Rosso Petra



117
Blu Jodhpur



004
Grigio



027
Nero

LEGNO SELECTION

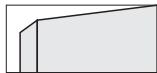

337
Olmo
americano



048
Noce colore



093
Noce
canaletto U.S.



101
Rovere
affumicato

METALS



198
Bianco



934
Aluminium



197
Zinco+



195
Ottone
Vintage



196
Rame+



191
Piombo



192
Titanio

CORIAN®



173
Bianco

B14

FINITURE REALIZZABILI - MOBILI

CONTENITORE
NOBILITATO



606
Olmo (effetto
poro aperto)

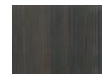

610
Larice
termico
(effetto poro
aperto)



608
Rovere grafite
(effetto poro
aperto)

FINITURA
FRONTALI

COLORI / ESSENZE

LEGNO MASSELLO

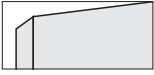

058
Noce LIGHT
canaletto
"taglio sega"



057
Abete "antico"
grigio



066
Olmo
americano
SW



067
Frassino olivato
termotrattato SW



102
Rovere tinto
affumicato
SW

LEGNO EXCLUSIVE



077
Abonos fossil
oak



SOPRAPIANO
da appoggio



SOPRAPIANO
da incasso



SOTTOPIANO
da incasso



FILOPIANO
stampato

FINITURA PIANI

COLORI / ESSENZE

LAVABI

CRISTALPLANT® - H 50 mm

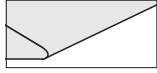

Bianco

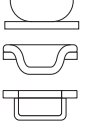

LASERMAT - H 20 mm

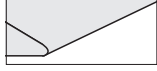

183
Bianco Kos



178
Bianco Malè



179
Beige Luxor



187
Beige Arizona



184
Grigio Efeso



181
Grigio Londra



202
Grigio Antrim



185
Grigio Bromo



203
Blu Fes



188
Verde
Comodoro



186
Cacao
Orinoco



182
Nero Ingo



189
Rosso Jaipur

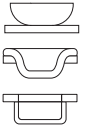

PIETRA - MARMO - GRANITO - H 20 mm

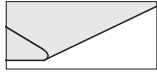

240
Marmo bianco
Carrara



250
Pietra Serena



257
Quarzite
Silver



199
Granito Nero
Assoluto
Zimbabwe



261
Marmo
Emperador
Dark



254
Granito Black
Cosmic



259
Quarzite
Calacatta



260
Marmo Grey
Stone



266
Marmo bianco
Carrara
Lithoverde®



265
Marmo Gris
du Marais
Lithoverde®



267
Pietra d'Avola
Lithoverde®

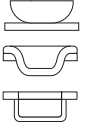

COMPOSITO DEKTON® - H 50 mm

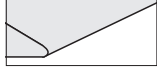

455
Beige Edora



453
Nero Sirius



454
Bianco Zenith



451
Grigio Strato



459
Marrone
Galema



461
Domoos



462
Keranium



460
Kelya

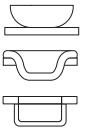

COMPOSITO MDI - H 50 mm



233
Bianco



234
Cammello



236
Visone



237
Grigio



238
Nero



231
Devon



232
Surrey

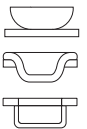

B14

Design Norbert Wengen

Wall hung, modular base units - middle or end use - without handle, with under-mounted handle-rail.

The door opening is allowed by the upper bevelled-edge door matched with the handle-rail and the bevelled-edge top.

Top (1)

The tops have visible bevelled edges, on one or more sides, according to the project.

35° slicing. (lower bevelled edge). (1a)

THICKNESS: 50 mm

DEPTH: 505 mm

COMPATIBLE WASHBASINS: top-mounted, built-in and under-mounted.

Unit (2)

It's made of 19 mm thick wood particle board panels, waterproof, with low formaldehyde emission (class E1, CARB P2 / TSCA Title VI certified), treated with high performance melamine resin. Front and back edges in ABS, same colour

SIDE PANEL HEIGHT: 300 - 635 mm (both compatible with built-in / under-mounted / moulded flush-mounted Boffi washbasins).

SIDE PANEL DEPTH: 470 mm.

DEPTH INCLUDING DOOR: 495 mm.

MODULE WIDTH: 300 - 450 - 600 - 900 - 1200 mm.

Doors and front panels (3)

Finished, thickness 23 mm, with upper bevelled edge (door type BN).

On end base units and end panels the vertical lateral edges are bevelled too.

Under top handle-rail (4)

In painted aluminium, placed between top and door, along all bevelled-edge top sides.

Longitudinal use. (4a)

Lateral use. (4b)

FINISHES: white - black.

Drawers (5)

LEGRABOX series with sides and back in varnished matt black metal.

Black melamine-coated bottom.

Front of internal drawers in melamine, same finish as carcass.

End panels (6)

In finishing, 23 mm thick.

Frontal and upper bevelled edges.

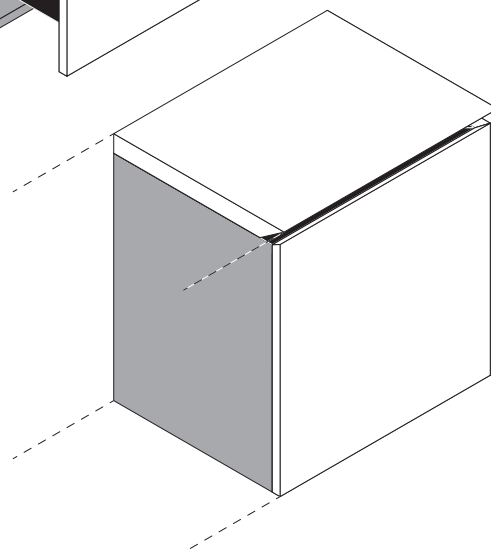
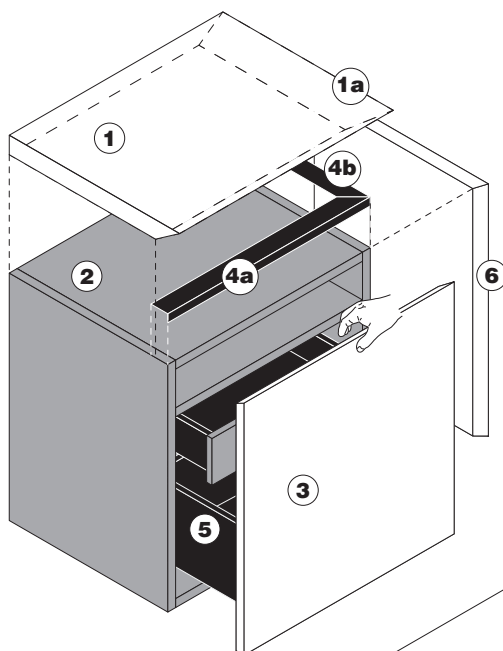

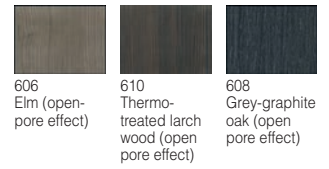

FRONT PANELS
FINISH

COLOURS / SPECIES

EASYLAK+

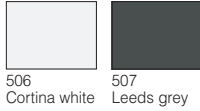
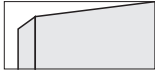

SILCOLAK

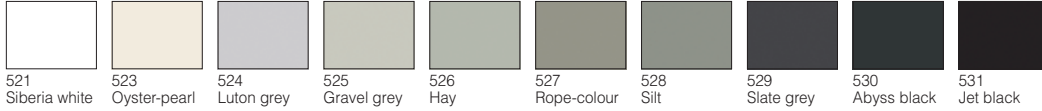
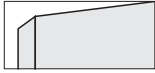

ECOLAK

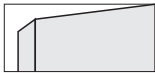

LASERMAT

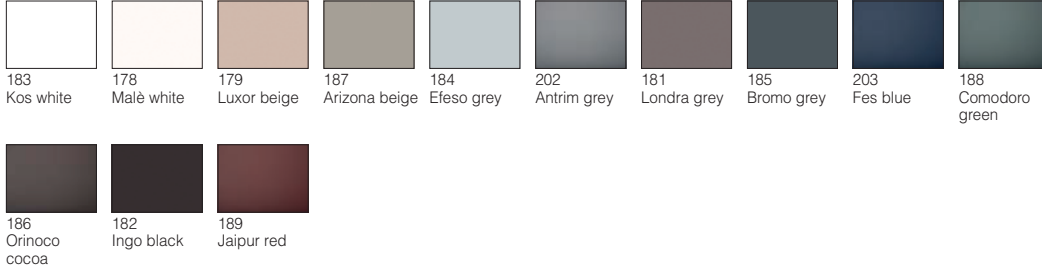
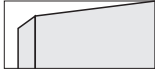

WOOD

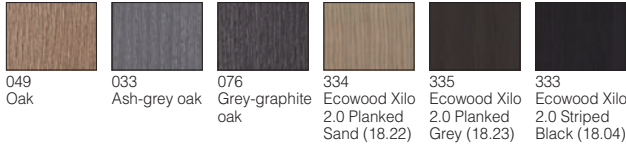
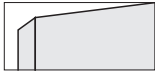

POLYESTER

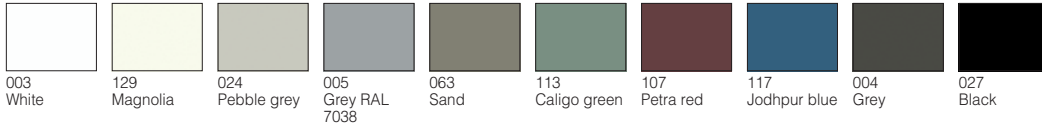

WOOD SELECTION



METALS

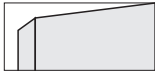

CORIAN®



B14

FEASIBLE FINISHES - CABINETS

MELAMINE-COATED
CARCASS



606
Elm (open-
pore effect)



610
Thermo-
treated larch
wood (open
pore effect)



608
Grey-graphite
oak (open
pore effect)

FRONT PANELS
FINISH

COLOURS / SPECIES

SOLID WOOD

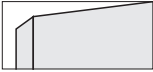

058
LIGHT Canaletto
walnut, "sawn"
effect



057
"Old" grey
pinewood



066
American elm
SW



067
Thermo-treated
Olivato ash
wood SW



102
Smoked dyed
oak SW

WOOD EXCLUSIVE

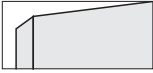

077
Abonos fossil
oak



TOPS FINISH

COLOURS / SPECIES

WASHBASINS

CRISTALPLANT® - H 50 mm

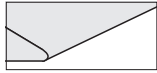

White

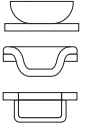

LASERMAT - H 20 mm



183
Kos white



178
Malè white



179
Luxor beige



187
Arizona beige



184
Efeso grey



181
Londra grey



202
Antrim grey



185
Bromo grey



203
Fes blue



188
Comodoro
green



186
Orinoco
cocoa



182
Ingo black



189
Jaipur red

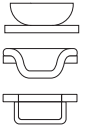

STONE - MARBLE - GRANITE - H 20 mm

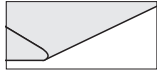

240
White Carrara
marble



250
Serena stone



257
Quartzite
Silver



199
Absolute black
Zimbabwe
granite



261
Emperador
Dark marble



254
Black Cosmic
granite



259
Quartzite
Calacatta



260
Grey Stone
marble



266
White Carrara
marble
Lithoverde®



265
Gris du
Marais marble
Lithoverde®



267
Pietra
d'Avola stone
Lithoverde®

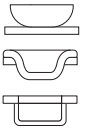

DEKTON® COMPOSITE - H 50 mm

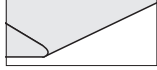

455
Edora beige



453
Sirius black



454
Zenith white



451
Strato grey



459
Galema
brown



461
Domoos



462
Keranium



460
Kelya

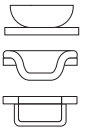

MDI COMPOSITE - H 50 mm



233
White



234
Camel



236
Mink



237
Grey



238
Black



231
Devon



232
Surrey

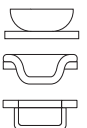

B14

Design Norbert Wangen

Système modulaire de bases suspendues en utilisation intermédiaire ou d'extrémité, sans poignée, avec profil poignée-bandeau sous plan.
La prise de main pour l'ouverture de la porte est obtenue grâce au chanfrein supérieur de la porte en assortiment avec la poignée-bandeau sous plan et le chanfrein périphérique du plan.

Plan (1)

Plan caractérisé par chanfreins inclinés apparents sur un ou plus côtés, en fonction du projet.

Tête latérale inclinée à 35°. (Chanfrein inférieure). (1a)

ÉPAISSEUR: 50 mm

PROFONDEUR: 505 mm

LAVABOS COMPATIBLES: sur plan d'appui, sur plan à encastrer et sous plan à encastrer.

Caisson (2)

Réalisé en panneaux de particules de bois d'épaisseur 19 mm, hydrofuges, à faible teneur en formaldéhyde (certifié classe E1 / CARB P2 / TSCA Title VI) mélaminé avec papiers à haute densité traités avec des résines mélaminiques. Chant avant et arrière en ABS de la même couleur.

HAUTEUR CÔTÉ: 300 - 635 mm (les deux compatibles avec lavabos Boffi sur plan à encastrer / sous plan à encastrer/ affleurants moulés).

PROFONDEUR CÔTÉ: 470 mm.

PROFONDEUR AVEC FAÇADE: 495 mm.

LARGEUR MODULE: 300 - 450 - 600 - 900 - 1200 mm.

Portes et façades (3)

Réalisées selon les finitions disponibles, épaisseur 23 mm, avec chanfrein supérieur (type porte BN).

Sur façades de bases utilisées en extrémité et panneaux d'extrémité chanfrein supplémentaire latéral vertical.

Poignée-bandeau sous plan (4)

Réalisée en aluminium peint, elle est prévue entre plan et porte le long de tous les côtés chanfreinés du plan.

Utilisation longitudinale. (4a)

Utilisation latérale. (4b)

FINITIONS: blanc - noir.

Tiroirs (5)

Système LEGRABOX, avec rebords latéraux et arrière en métal peint en couleur noir mat.

Fond en mélaminé noir.

Façade tiroirs internes en mélaminé finition caisson.

Panneau d'extrémité (6)

Réalisées selon les finitions disponibles, épaisseur 23 mm.

Chanfrein sur chant avant et supérieur.

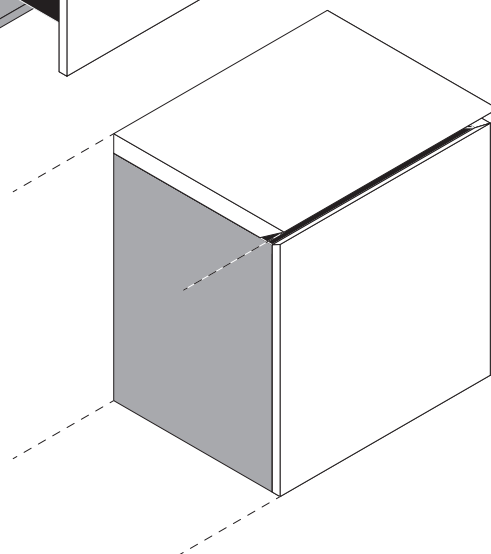
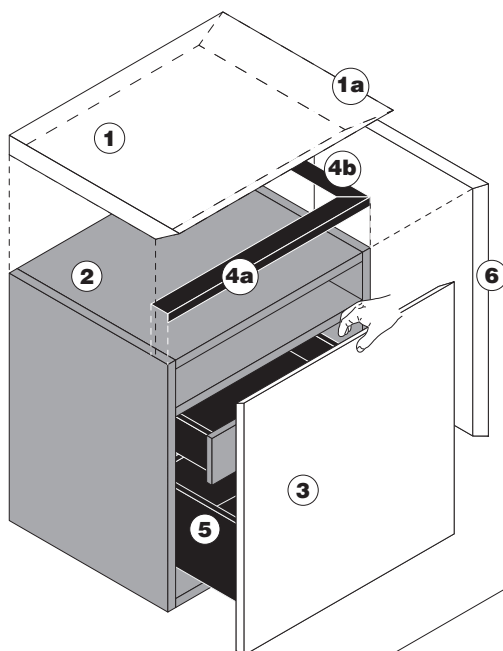



606
Orme (effet
pores
ouverts)

610
Mélèze
thermique
(effet pores
ouverts)

608
Chêne
graphite
(effet pores
ouverts)

FINITION FAÇADES COULEURS / ESSENCES

EASYLAK+

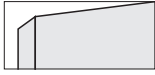

506
Blanc Cortina

507
Gris Leeds

SILCOLAK

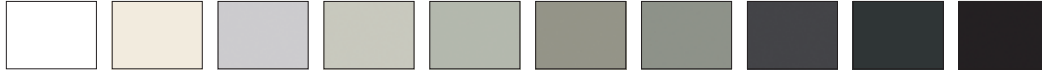
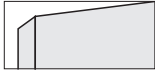

521
Blanc Sibérie

523
Hûître

524
Gris Luton

525
Gravier

526
Foin

527
Corde

528
Limon

529
Ardoise

530
Noir abysse

531
Noir intense

ECOLAK

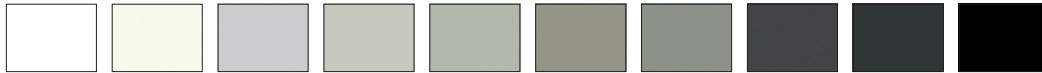
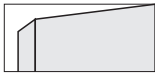

510
Blanc arctique

129
Magnolia

513
Nuage

024
Galet

512
Avoine

025
Ecrû

023
Boue

515
Basalte

517
Charbon

027
Noir

LASERMAT

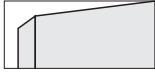

183
Blanc Kos

178
Blanc Malè

179
Beige Luxor

187
Beige Arizona

184
Gris Efeso

202
Gris Antrim

181
Gris Londra

185
Gris Bromo

203
Bleu Fes

188
Vert Comodoro



186
Cacao Orinoco

182
Noir Ingo

189
Rouge Jaipur

BOIS

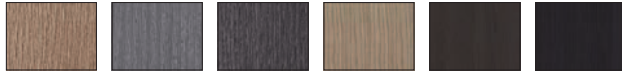
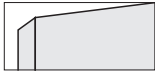

049
Chêne

033
Chêne cendré
gris

076
Chêne
graphite

334
Ecowood Xilo
2.0 Planked
Sand (18.22)

335
Ecowood Xilo
2.0 Planked
Grey (18.23)

333
Ecowood Xilo
2.0 Striped
Black (18.04)

POLYESTER

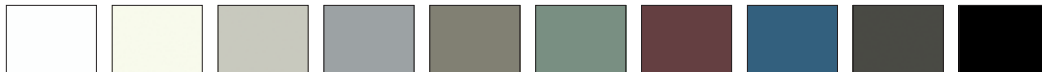
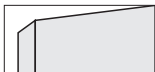

003
Blanc

129
Magnolia

024
Galet

005
Gris RAL
7038

063
Sable

113
Vert caligo

107
Rouge Petra

117
Bleu Jodhpur

004
Gris

027
Noir

BOIS SELECTION

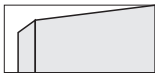

337
Orme
Américain

048
Cœur de
noyer

093
Noyer
"canaletto"
U.S.

101
Chêne fumé

METALS

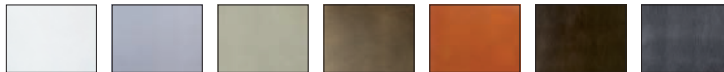

198
Blanc

934
Aluminium

197
Zinc+

195
Laiton Vintage

196
Cuivre+

191
Plomb

192
Titane

CORIAN®



173
Blanc

606
Orme (effet
pores
ouverts)610
Mélèze
thermique
(effet pores
ouverts)608
Chêne
graphite
(effet pores
ouverts)

FINITION FAÇADES COULEURS / ESSENCES

BOIS MASSIF

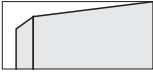
058
Noyer LIGHT
canaletto
"effet scié"057
Sapin
"antique" gris066
Orme
Américain SW067
Frêne olivier
thermotraité SW102
Chêne teinté
fumé SW

BOIS EXCLUSIVE

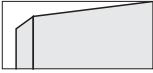
077
Abonos fossil
oak



SUR PLAN
d'appui



SUR PLAN à
encastrer



SOUS PLAN
à encastrer



AFFLEURANT
moulé

FINITION PLANS

COULEURS / ESSENCES

LAVABOS

CRISTALPLANT® - H 50 mm

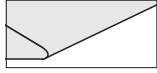

Blanc



LASERMAT - H 20 mm

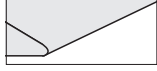

183
Blanc Kos



178
Blanc Malè



179
Beige Luxor



187
Beige Arizona



184
Gris Efeso



181
Gris Londra



202
Gris Antrim



185
Gris Bromo



203
Bleu Fes



188
Vert
Comodoro



186
Cacao
Orinoco



182
Noir Ingo



189
Rouge Jaipur

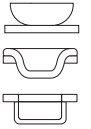

PIERRE - MARBRE - GRANITE - H 20 mm

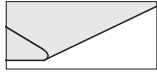

240
Marbre blanc
Carrara



250
Pierre Serena



257
Quartzite
Silver



199
Granite
Noir Absolu
Zimbabwe



261
Marbre
Emperador
Dark



254
Granite Black
Cosmic



259
Quartzite
Calacatta



260
Marbre Grey
Stone



266
Marbre blanc
Carrara
Lithoverde®



265
Marbre Gris
du Marais
Lithoverde®



267
Pietra d'Avola
Lithoverde®

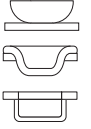

COMPOSITE DEKTON® - H 50 mm

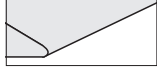

455
Beige Edora



453
Noir Sirius



454
Blanc Zenith



451
Gris Strato



459
Marron
Galema



461
Domoos



462
Keranium



460
Kelya

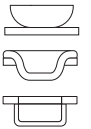

COMPOSITE MDI - H 50 mm



233
Blanc



234
Chameau



236
Vison



237
Gris



238
Noir



231
Devon



232
Surrey

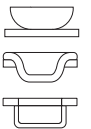

B14

Design Norbert Wangen

Modulares System aus Hänge-Unterschrank, Zwischen- oder Endelementen, ohne Griff, mit Griffleiste unter der Waschtischplatte.
Die obere abgeschrägte Kante der Tür, die Griffleiste unterhalb der Waschtischplatte und die umlaufende Abkantung der Waschtischplatte erleichtern das Öffnen der Tür.

Waschtischplatte (1)

Waschtischplatte hervorgehoben durch abgewinkelte Kanten an 1 oder mehreren Seiten, je nach Plan.

Seitenbearbeitung 35°. (Unterabschrägung). (1a)

STÄRKE: 50 mm.

TIEFE: 505 mm.

KOMPATIBLE WASHBECKEN: Aufsatz-, Einbau- von oben und Unterbaubecken.

Schrank (2)

Aus Paneelen aus Spanplatte, Stärke 19 mm, wasserabweisend, mit geringem Formaldehydgehalt (zertifiziert Klasse E1, CARB P2 / TSCA Title VI), mit Melaminharzbeschichtung mit hoher Dichte. Vordere und rückseitige Kante aus ABS in Ausführung.

SEITENTEIL HÖHE: 300 - 635 mm (beide sind kompatibel mit Einbaubecken von oben / Unterbaubecken / flächenbündigen formgepressten Waschbecken Boffi).

SEITENTEIL TIEFE: 470 mm.

TIEFE MIT FRONTPANEEL: 495 mm.

ELEMENTENBREITE: 300 - 450 - 600 - 900 - 1200 mm.

Türen und Frontpaneele (3)

In Ausführung, Stärke 23 mm, mit oberer Abschrägung (Tür Typ BN).

An Frontpaneelen von Abschluss-Unterschrank und Abschlusspaneelen zusätzlich vertikale Abschrägung an der Seite.

Griffleiste unter Waschtischplatte (4)

Aus lackiertem Aluminium, vorgesehen zwischen Waschtischplatte und Tür an allen Seiten der abgewinkelten Waschtischplatte.

Längsseitige Verwendung. (4a)

Seitliche Verwendung. (4b)

AUSFÜHRUNGEN: weiß - schwarz.

Schubladen (5)

System LEGRABOX, mit rückseitiger Blende und Seitenblenden aus mattschwarz lackiertem Metall.

Boden mit Melaminharzbeschichtung schwarz.

Frontpaneele der Innenschubladen mit Melaminbeschichtung Ausführung Schrankelement.

Abschlusspaneel (6)

In Ausführung, St. 23 mm.

Abschrägung an Vorder- und Oberkante.

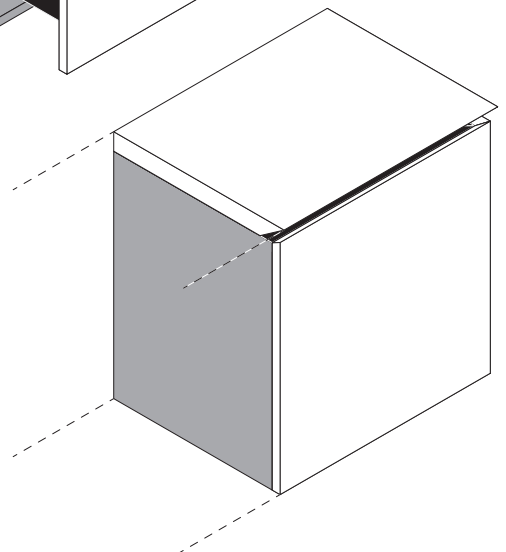
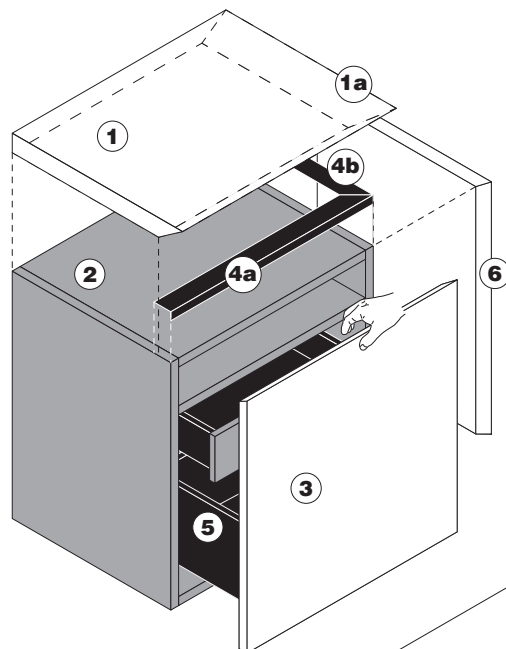

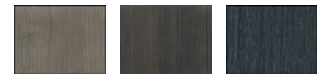

606
Ulme (Effekt
offenporig)

610
Thermoholz
Lärche (Effekt
offenporig)

608
Eiche
grafitgrau
(Effekt
offenporig)

AUSFÜHRUNG
FRONTEN

FARBEN / HOLZARTEN

EASYLAK+

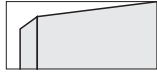

506
Weiß Cortina

507
Grau Leeds

SILCOLAK

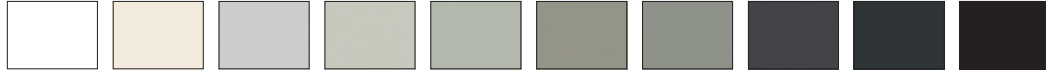

521
Weiß Sibirien

523
Perlweiß

524
Grau Luton

525
Grau Schotter

526
Heu

527
Naturfarben

528
Schlamm

529
Ardoise

530
Völlig schwarz

531
Tiefschwarz

ECOLAK

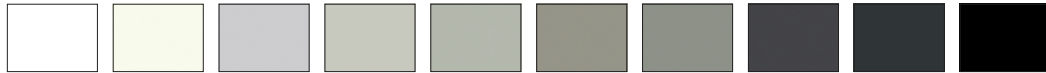
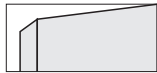

510
Arktischweiß

129
Magnolie

513
Wolkenfarben

024
Kieselgrau

512
Haferfarben

025
Ekrü

023
Lehm Braun

515
Basaltgrau

517
Kohlenschwarz

027
Schwarz

LASERMAT

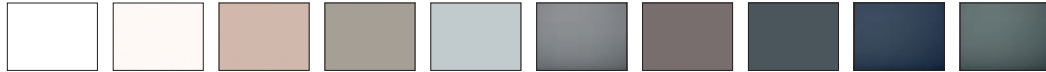
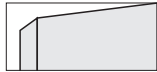

183
Weiß Kos

178
Weiß Kos

179
Beige Luxor

187
Beige Arizona

184
Grau Efeso

202
Grau Antrim

181
Grau Londra

185
Grau Bromo

203
Blue Fes

188
Grün
Comodoro



186
Kakao
Orinoco

182
Schwarz Ingo

189
Rot Jaipur

HOLZ

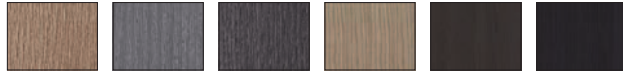
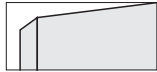

049
Eiche

033
Eiche
Aschgrau

076
Eiche
Grafitgrau

334
Ecowood Xilo
2.0 Planked
Sand (18.22)

335
Ecowood Xilo
2.0 Planked
Grey (18.23)

333
Ecowood Xilo
2.0 Striped
Black (18.04)

POLYESTER

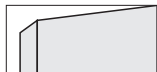

003
Weiß

129
Magnolie

024
Kieselgrau

005
Grau RAL
7038

063
Sandfarben

113
Grün caligo

107
Rot Petra

117
Blue Jodhpur

004
Grau

027
Schwarz

HOLZ SELECTION

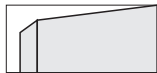

337
Amerikanische
Ulme

048
Kern-
Nussbaum

093
Nussbaum
Canaletto
U.S.

101
Räuhereiche

METALS

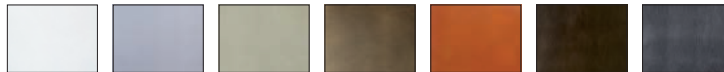

198
Weiß

934
Aluminium

197
Zink+

195
Messing
Vintage

196
Kupfer+

191
Blei

192
Titan

CORIAN®



173
Weiß

B14

ERHÄLTICHE AUSFÜHRUNGEN - ELEMENTE

MELAMINBESCHICHTETES
SCHRANKELEMENT



606
Ulme (Effekt
offenporig)



610
Thermoholz
Lärche (Effekt
offenporig)



608
Eiche
grafitgrau
(Effekt
offenporig)

AUSFÜHRUNG
FRONTEN

FARBEN / HOLZARTEN

MASSIVHOLZ

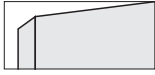

058
Nussbaum LIGHT Caraleto
Sägechnitt



057
„Antikes“
Tannenholz
grau



066
Amerikanische
Ulme SW



067
Thermo-
Olivesche SW



102
Räuchereiche
gebeizt SW

HOLZ EXCLUSIVE

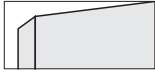

077
Abonos fossil
oak



AUFSATZBECKEN



EINBAUBECKEN
von oben



UNTERBAUBECKEN



FLÄCHENBÜNDIG
formgepresst

AUSFÜHRUNG

WASCHTISCHPLATTEN FARBEN / HOLZARTEN

WASCHBECKEN

CRISTALPLANT® - H 50 mm

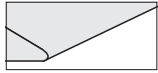

Weiß

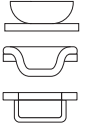

LASERMAT - H 20 mm



183
Weiß Kos



178
Weiß Kos



179
Beige Luxor



187
Beige Arizona



184
Grau Efeso



181
Grau Londra



202
Grau Antrim



185
Grau Bromo



203
Blue Fes



188
Grün
Comodoro



186
Kakao
Orinoco



182
Schwarz Ingo



189
Rot Jaipur

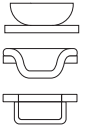

STEIN - MARMOR - GRANIT - H 20 mm

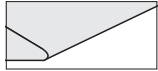

240
Carrara-
Marmor weiß



250
Stein Serena



257
Quarzit Silver



199
Granit
Tiefschwarz
Zimbabwe



261
Marmor
Emperador
Dark



254
Granit Black
Cosmic



259
Quarzit
Calacatta



260
Marmor Grey
Stone



266
Marmor
weiß Carrara
Lithoverde®



265
Marmor Gris
du Marais
Lithoverde®



267
Stein Pietra
D'Avola
Lithoverde®

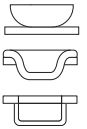

AGGLOMERAT DEKTON® - H 50 mm



455
Beige Edora



453
Schwarz
Sirius



454
Weiß Zenith



451
Grau Strato



459
Braun Galema



461
Domoos



462
Keranium



460
Kelya

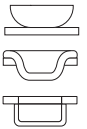

AGGLOMERAT MDI - H 50 mm



233
Weiß



234
Kamel



236
Nerz



237
Grau



238
Schwarz



231
Devon



232
Surrey

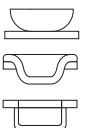

B14

Design Norbert Wangen

Sistema modular de muebles contenedores bajos suspendidos para uso intermedio o terminal, sin tirador, con perfil tirador bajo la encimera.

La empuñadura para abrir la puerta se obtiene gracias al chaflán superior de la puerta misma en combinación con el perfil tirador bajo encimera y el chaflán perimetral de la encimera.

Encimera (1)

Encimera caracterizada por chaflanes inclinados a la vista en uno o varios lados, dependiendo del proyecto.

Cabecera lateral inclinada en 35°. (Bisel inferior). (1a)

GROSOR: 50 mm.

PROFUNDIDAD: 505 mm.

LAVABOS COMPATIBLES: sobre encimera apoyado, sobre encimera empotrado y bajo encimera empotrado.

Contenedor (2)

Realizados en paneles de partículas de madera grosor 19 mm, hidrófugos, con bajo contenido de formaldehído (certificado clase E1, CARB P2/ TSCA Title VI) melamínico con papeles con alto gramaje tratados con resinas melamínicas. Borde delantero y trasero en ABS del mismo color.

ALTURA COSTADO: 300 - 635 mm (ambas compatibles con lavabos Boffi sobre encimera empotrados / bajo encimera empotrados / enrasados a la encimera moldeados).

PROFUNDIDAD COSTADO: 470 mm.

PROFUNDIDAD CON FRENTE: 495 mm.

ANCHURA MÓDULO: 300 - 450 - 600 - 900 - 1200 mm.

Puertas y frentes (3)

Realizadas en acabado, grosor 23 mm con chaflán superior (tipo puerta BN).

En traseras de bases a uso terminal y paneles terminal chaflán añadido lateral vertical.

Perfil tirador bajo encimera (4)

Realizado en aluminio pintado, está prevista entre encimera y puerta a lo largo de todos los lados achaflanados de la encimera.

Uso longitudinal. (4a)

Uso lateral. (4b)

ACABADOS: blanco - negro.

Cajones (5)

Sistema LEGRABOX, con bordes laterales y posteriores en metal lacado en color negro mate.

Fondo de madera ennoblecida negra.

Frente cajones internos en madera ennoblecida acabado mueble contenedor.

Panel terminal (6)

Realizado en acabado, grosor 23 mm.

Chaflán en el borde frontal y superior.

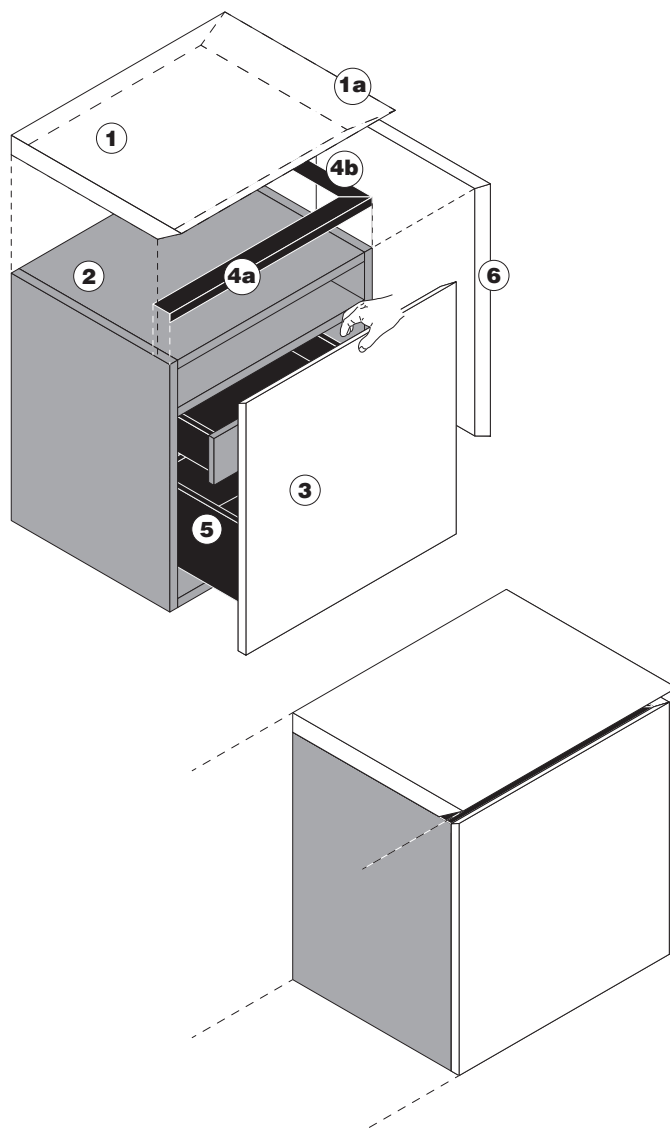

B14

ACABADOS REALIZABLES - MUEBLES

MUEBLE
CONTENEDOR
ENNOBLECIDO.



606
Olmo (efecto
poro abierto)

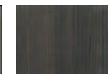

610
Alerce
térmico
(efecto poro
abierto)



608
Roble grafito
(efecto poro
abierto)

ACABADO FRENTES

COLORES / MADERAS

EASYLAK+

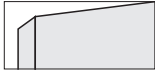

506
Blanco
Cortina



507
Gris Leeds

SILCOLAK

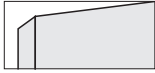

521
Blanco
Siberia



523
Ostra



524
Gris Luton



525
Grava



526
Heno



527
Cuerda



528
Limo



529
Pizarra



530
Negro Abismo



531
Negro Intenso

ECOLAK

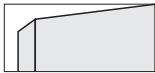

510
Blanco ártico



129
Magnolia



513
Nube



024
Guijarro



512
Avena



025
Crudo



023
Fango



515
Basalto



517
Carbón



027
Negro

LASERMAT

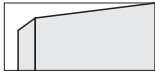

183
Blanco Kos



178
Blanco Malè



179
Beige Luxor



187
Beige Arizona



184
Gris Efeso



202
Gris Antrim



181
Gris Londra



185
Gris Bromo



203
Azul Fes



188
Verde
Comodoro



186
Cacao
Orinoco



182
Negro Ingo



189
Rojo Jaipur

MADERA

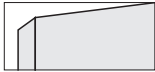

049
Roble



033
Roble ceniza



076
Roble grafito



334
Ecowood Xilo
2.0 Planked
Sand (18.22)



335
Ecowood Xilo
2.0 Planked
Grey (18.23)



333
Ecowood Xilo
2.0 Striped
Black (18.04)

POLIÉSTER

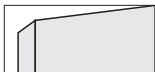

003
Blanco



129
Magnolia



024
Guijarro



005
Gris RAL
7038



063
Arena



113
Verde caligo



107
Rojo Petra



117
Azul Jodhpur



004
Gris



027
Negro

MADERA SELECTION

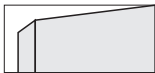

337
Olmo
americano



048
Alma de
nogal



093
Nogal canaletto
(americano)
U.S.



101
Roble
ahumado

METALS



198
Blanco



934
Aluminium



197
Zink+



195
Latón Vintage



196
Cobre+



191
Plomo



192
Titanio

CORIAN®



173
Blanco

B14

ACABADOS REALIZABLES - MUEBLES

MUEBLE
CONTENEDOR
ENNOBLECIDO.



606
Olmo (efecto
poro abierto)



610
Alerce
térmico
(efecto poro
abierto)



608
Roble grafito
(efecto poro
abierto)

ACABADO
FRENTEROS

COLORES / MADERAS

MADERA MACIZA

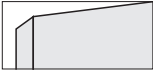

058
Nogal LIGHT
canaletto
"corte sierra"



057
Abeto
"antiguo" gris



066
Olmo
americano
SW



067
Fresno Olivato
termotratado SW



102
Roble teñido
ahumado SW

MADERA EXCLUSIVE

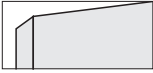

077
Abonos fossil
oak



SOBRE
ENCIMERA
apoyado



SOBRE
ENCIMERA
empotrado



BAJO
ENCIMERA
empotrado



ENRASADO
A LA
ENCIMERA
moldeado

ACABADO
ENCIMERAS

COLORES / MADERAS

LAVABOS

CRISTALPLANT® - H 50 mm

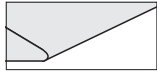

Blanco

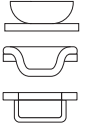

LASERMAT - H 20 mm

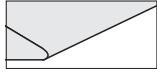

183
Blanco Kos



178
Blanco Malé



179
Beige Luxor



187
Beige Arizona



184
Gris Efeso



181
Gris Londra



202
Gris Antrim



185
Gris Bromo



203
Azul Fes



188
Verde
Comodoro



186
Cacao
Orinoco



182
Negro Ingo



189
Rojo Jaipur

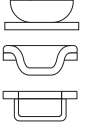

PIEDRA - MÁRMOL - GRANITO - H 20 mm

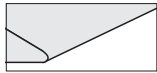

240
Mármol
blanco
Carrara



250
Piedra Serena



257
Cuarcita Silver



199
Granito Negro
Absoluto
Zimbabwe



261
Mármol
Emperador
Dark



254
Granito Black
Cosmic



259
Cuarcita
Calacatta



260
Mármol Grey
Stone



266
Mármol blanco
Carrara
Lithoverde®



265
Mármol Gris
du Marais
Lithoverde®



267
Pietra d'Avola
Lithoverde®

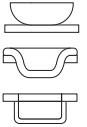

COMPUESTO DEKTON® - H 50 mm

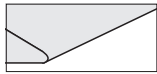

455
Beige Edora



453
Negro Sirius



454
Blanco Zenith



451
Gris Strato



459
Marrón
Galema



461
Domoos



462
Keranium



460
Kelya

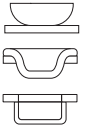

COMPUESTO MDI - H 50 mm

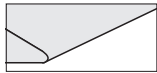

233
Blanco



234
Camello



236
Visón



237
Gris



238
Negro



231
Devon



232
Surrey

