

# B14

Design Norbert Wangen

Sistema modulare di contenitori base sospesi ad uso intermedio o terminale, senza maniglia, con profilo fascia maniglia sottopiano.

L'impugnatura per l'apertura dell'anta è ottenuta grazie allo smusso superiore dell'anta stessa in combinazione con la fascia maniglia sottopiano e lo smusso perimetrale del piano.

## Piano (1)

Piano caratterizzato da smussi inclinati a vista su uno o più lati, in funzione del progetto.

Testata laterale inclinata a 35°. (Smusso inferiore). (1a)

SPESSORE: 50 mm.

PROFONDITÀ: 505 mm.

LAVABI COMPATIBILI: soprapiano da appoggio, soprapiano da incasso e sottopiano da incasso.

## Contenitore (2)

Realizzato in pannelli di particelle di legno di spessore 19 mm, idrofughi, a basso contenuto di formaldeide (certificato classe E1, CARB P2 / TSCA Title VI) nobilitato con carte ad alta grammatura trattate con resine melamminiche. Bordo anteriore e posteriore in ABS in tinta.

ALTEZZA FIANCO: 300 - 635 mm (entrambe compatibili con lavabi Boffi soprapiano da incasso / sottopiano da incasso / filopiano stampato).

PROFONDITÀ FIANCO: 470 mm.

PROFONDITÀ CON FRONTALE: 495 mm.

LARGHEZZA MODULO: 300 - 450 - 600 - 900 - 1200 mm.

## Ante e frontali (3)

Realizzate in finitura, spessore 23 mm, con smusso superiore (tipo anta BN).

Su frontali di basi ad uso terminale e pannelli terminali smusso aggiuntivo laterale verticale.

## Fascia maniglia sottopiano (4)

Realizzata in alluminio verniciato, è prevista tra piano e anta lungo tutti i lati smussati del piano.

Uso longitudinale. (4a)

Uso laterale. (4b)

FINITURE: bianco - nero.

## Cassetti (5)

Sistema LEGRABOX, con spondine laterali e posteriore in metallo verniciato in colore nero opaco.

Fondo in nobilitato nero.

Frontale cassetti interni in nobilitato finitura contenitore.

## Pannello terminale (6)

Realizzato in finitura, spessore 23 mm.

Smusso su bordo frontale e superiore.

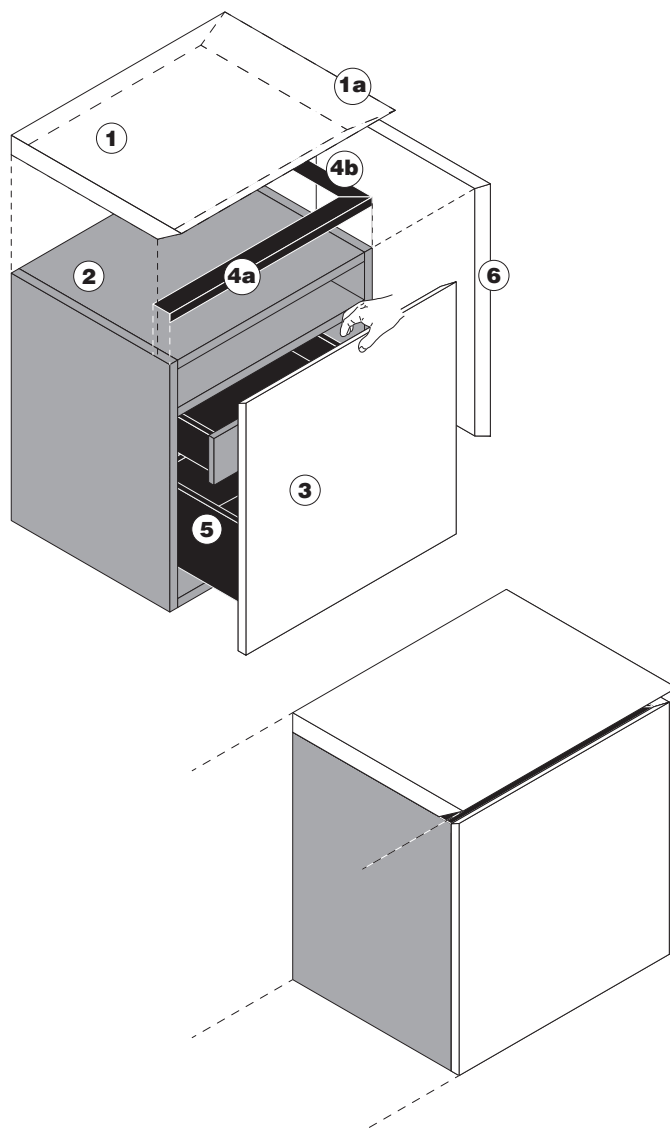



FINITURA  
FRONTALI

COLORI / ESSENZE

EASYLAK+

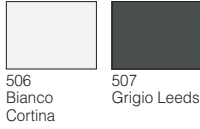
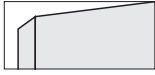

SILCOLAK

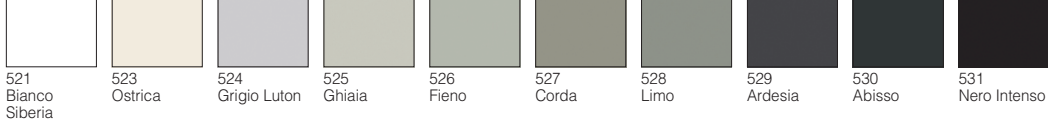

ECOLAK

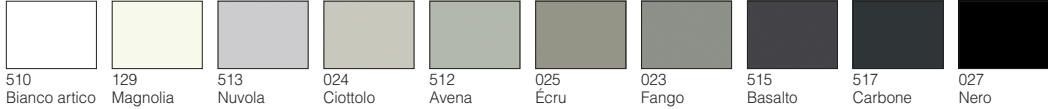

LASERMAT

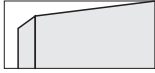

LEGNO

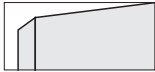

POLIESTERE

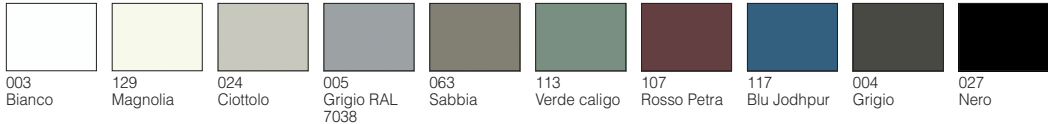

LEGNO SELECTION



METALS

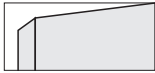

CORIAN®



# B14

FINITURE REALIZZABILI - MOBILI

CONTENITORE  
NOBILITATO



606  
Olmo (effetto  
poro aperto)



610  
Larice  
termico  
(effetto poro  
aperto)



608  
Rovere grafite  
(effetto poro  
aperto)

FINITURA  
FRONTALI

COLORI / ESSENZE

## LEGNO MASSELLO

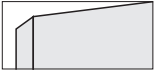

058  
Noce LIGHT  
canaletto  
"taglio sega"



057  
Abete "antico"  
grigio



066  
Olmo  
americano  
SW



067  
Frassino olivato  
termotrattato SW



102  
Rovere tinto  
affumicato  
SW

## LEGNO EXCLUSIVE

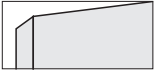

077  
Fossil oak



SOPRAPIANO  
da appoggio



SOPRAPIANO  
da incasso



SOTTOPIANO  
da incasso



FILOPIANO  
stampato

FINITURA PIANI      COLORI / ESSENZE

LAVABI

CRISTALPLANT® - H 50 mm

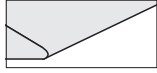

Bianco

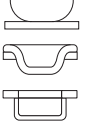

LASERMAT - H 20 mm

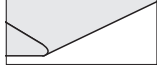

183  
Bianco Kos



178  
Bianco Malè



179  
Beige Luxor



187  
Beige Arizona



184  
Grigio Efeso



181  
Grigio Londra



202  
Grigio Antrim



185  
Grigio Bromo



203  
Blu Fes



188  
Verde  
Comodoro



186  
Cacao  
Orinoco



182  
Nero Ingo



189  
Rosso Jaipur

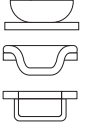

PIETRA - MARMO - GRANITO - H 20 mm

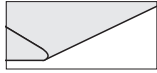

240  
Marmo bianco  
Carrara



250  
Pietra Serena



257  
Quarzite  
Silver



199  
Granito Nero  
Assoluto  
Zimbabwe



261  
Marmo  
Emperador  
Dark



254  
Granito Black  
Cosmic



259  
Quarzite  
Calacatta



260  
Marmo Grey  
Stone



266  
Marmo bianco  
Carrara  
Lithoverde®



265  
Marmo Gris  
du Marais  
Lithoverde®



267  
Pietra d'Avola  
Lithoverde®

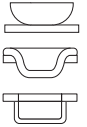

COMPOSITO DEKTON® - H 50 mm

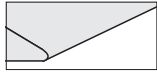

455  
Beige Edora



453  
Nero Sirius



454  
Bianco Zenith



451  
Grigio Strato



459  
Marrone  
Galema



461  
Domoos



462  
Keranium



460  
Kelya

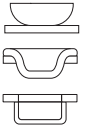

COMPOSITO MDI - H 50 mm



233  
Bianco



234  
Cammello



236  
Visone



237  
Grigio



238  
Nero



231  
Devon



232  
Surrey

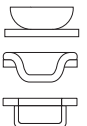

# B14

Design Norbert Wangen

Wall hung, modular base units - middle or end use - without handle, with under-mounted handle-rail.

The door opening is allowed by the upper bevelled-edge door matched with the handle-rail and the bevelled-edge top.

## Top (1)

The tops have visible bevelled edges, on one or more sides, according to the project.

35° slicing. (lower bevelled edge). (1a)

THICKNESS: 50 mm

DEPTH: 505 mm

COMPATIBLE WASHBASINS: top-mounted, built-in and under-mounted.

## Unit (2)

It's made of 19 mm thick wood particle board panels, waterproof, with low formaldehyde emission (class E1, CARB P2 / TSCA Title VI certified), treated with high performance melamine resin. Front and back edges in ABS, same colour

SIDE PANEL HEIGHT: 300 - 635 mm (both compatible with built-in / under-mounted / moulded flush-mounted Boffi washbasins).

SIDE PANEL DEPTH: 470 mm.

DEPTH INCLUDING DOOR: 495 mm.

MODULE WIDTH: 300 - 450 - 600 - 900 - 1200 mm.

## Doors and front panels (3)

Finished, thickness 23 mm, with upper bevelled edge (door type BN).

On end base units and end panels the vertical lateral edges are bevelled too.

## Under top handle-rail (4)

In painted aluminium, placed between top and door, along all bevelled-edge top sides.

Longitudinal use. (4a)

Lateral use. (4b)

FINISHES: white - black.

## Drawers (5)

LEGRABOX series with sides and back in varnished matt black metal.

Black melamine-coated bottom.

Front of internal drawers in melamine, same finish as carcass.

## End panels (6)

In finishing, 23 mm thick.

Frontal and upper bevelled edges.

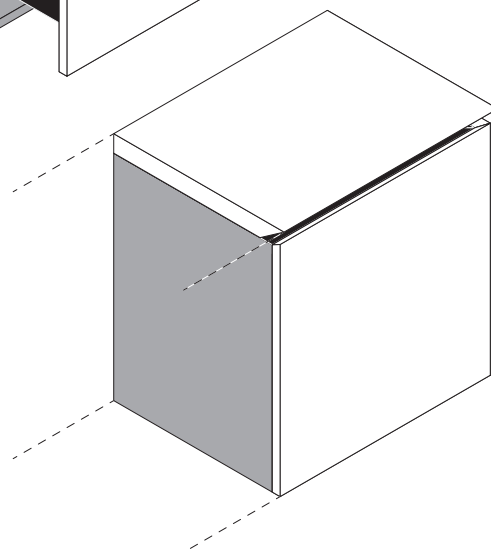
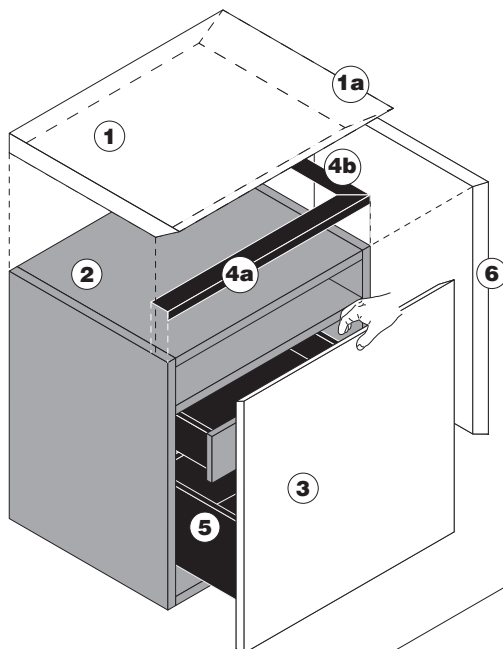



606  
Elm (open-  
pore effect)



610  
Thermo-  
treated larch  
wood (open  
pore effect)



608  
Grey-graphite  
oak (open  
pore effect)

FRONT PANELS  
FINISH

COLOURS / SPECIES

EASYLAK+

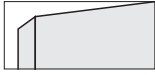

506  
Cortina white



507  
Leeds grey

SILCOLAK

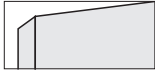

521  
Siberia white



523  
Oyster-pearl



524  
Luton grey



525  
Gravel grey



526  
Hay



527  
Rope-colour



528  
Silt



529  
Slate grey



530  
Abyss black



531  
Jet black

ECOLAK

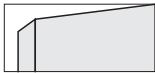

510  
Arctic white



129  
Magnolia



513  
Cloud colour



024  
Pebble grey



512  
Oat colour



025  
Ecru



023  
Mud



515  
Basalt grey



517  
Charcoal



027  
Black

LASERMAT

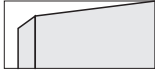

183  
Kos white



178  
Malè white



179  
Luxor beige



187  
Arizona beige



184  
Efeso grey



202  
Antrim grey



181  
Londra grey



185  
Bromo grey



203  
Fes blue



188  
Comodoro  
green



186  
Orinoco  
cocoa



182  
Ingo black



189  
Jaipur red

WOOD

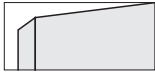

049  
Oak



033  
Ash-grey oak



076  
Grey-graphite  
oak



334  
Ecowood Xilo  
2.0 Planked  
Sand (18.22)



335  
Ecowood Xilo  
2.0 Planked  
Grey (18.23)



333  
Ecowood Xilo  
2.0 Striped  
Black (18.04)

POLYESTER



003  
White



129  
Magnolia



024  
Pebble grey



005  
Grey RAL  
7038



063  
Sand



113  
Caligo green



107  
Petra red



117  
Jodhpur blue



004  
Grey



027  
Black

WOOD SELECTION

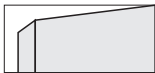

337  
American elm



048  
Core walnut



093  
Canaletto  
walnut U.S.



101  
Smoked oak

METALS



198  
White



934  
Aluminium



197  
Zinc+



195  
Vintage brass



196  
Copper+



191  
Lead



192  
Titanium

CORIAN®



173  
White

# B14

FEASIBLE FINISHES - CABINETS

MELAMINE-COATED  
CARCASS



606  
Elm (open-  
pore effect)



610  
Thermo-  
treated larch  
wood (open  
pore effect)



608  
Grey-graphite  
oak (open  
pore effect)

FRONT PANELS  
FINISH

COLOURS / SPECIES

## SOLID WOOD



058  
LIGHT Canaletto  
walnut, "sawn"  
effect



057  
"Old" grey  
pinewood



066  
American elm  
SW



067  
Thermo-treated  
Olivato ash  
wood SW



102  
Smoked dyed  
oak SW

## WOOD EXCLUSIVE



077  
Fossil oak



TOP-MOUNTED



BUILT-IN



UNDER-MOUNTED



moulded  
FLUSH-MOUNTED

TOPS FINISH

COLOURS / SPECIES

WASHBASINS

CRISTALPLANT® - H 50 mm

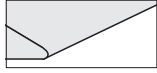

White

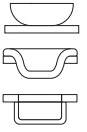

LASERMAT - H 20 mm



183  
Kos white



178  
Malè white



179  
Luxor beige



187  
Arizona beige



184  
Efeso grey



181  
Londra grey



202  
Antrim grey



185  
Bromo grey



203  
Fes blue



188  
Comodoro  
green



186  
Orinoco  
cocoa



182  
Ingo black



189  
Jaipur red

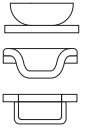

STONE - MARBLE - GRANITE - H 20 mm

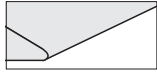

240  
White Carrara  
marble



250  
Serena stone



257  
Quartzite  
Silver



199  
Absolute black  
Zimbabwe  
granite



261  
Emperador  
Dark marble



254  
Black Cosmic  
granite



259  
Quartzite  
Calacatta



260  
Grey Stone  
marble



266  
White Carrara  
marble  
Lithoverde®



265  
Gris du  
Marais marble  
Lithoverde®



267  
Pietra  
d'Avola stone  
Lithoverde®

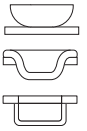

DEKTON® COMPOSITE - H 50 mm



455  
Edora beige



453  
Sirius black



454  
Zenith white



451  
Strato grey



459  
Galema  
brown



461  
Domoos



462  
Keranium



460  
Kelya

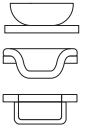

MDI COMPOSITE - H 50 mm

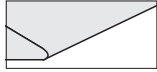

233  
White



234  
Camel



236  
Mink



237  
Grey



238  
Black



231  
Devon



232  
Surrey

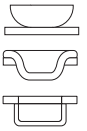



# B14

Design Norbert Wangen

Système modulaire de bases suspendues en utilisation intermédiaire ou d'extrémité, sans poignée, avec profil poignée-bandeau sous plan.

La prise de main pour l'ouverture de la porte est obtenue grâce au chanfrein supérieur de la porte en assortiment avec la poignée-bandeau sous plan et le chanfrein périphérique du plan.

## Plan (1)

Plan caractérisé par chanfreins inclinés apparents sur un ou plus côtés, en fonction du projet.

Tête latérale inclinée à 35°. (Chanfrein inférieure). (1a)

ÉPAISSEUR: 50 mm

PROFONDEUR: 505 mm

LAVABOS COMPATIBLES: sur plan d'appui, sur plan à encastrer et sous plan à encastrer.

## Caisson (2)

Réalisé en panneaux de particules de bois d'épaisseur 19 mm, hydrofuges, à faible teneur en formaldéhyde (certifié classe E1 / CARB P2 / TSCA Title VI) mélaminé avec papiers à haute densité traités avec des résines mélaminiques. Chant avant et arrière en ABS de la même couleur.

HAUTEUR CÔTÉ: 300 - 635 mm (les deux compatibles avec lavabos Boffi sur plan à encastrer / sous plan à encastrer/ affleurants moulés).

PROFONDEUR CÔTÉ: 470 mm.

PROFONDEUR AVEC FAÇADE: 495 mm.

LARGEUR MODULE: 300 - 450 - 600 - 900 - 1200 mm.

## Portes et façades (3)

Réalisées selon les finitions disponibles, épaisseur 23 mm, avec chanfrein supérieur (type porte BN).

Sur façades de bases utilisées en extrémité et panneaux d'extrémité chanfrein supplémentaire latéral vertical.

## Poignée-bandeau sous plan (4)

Réalisée en aluminium peint, elle est prévue entre plan et porte le long de tous les côtés chanfreinés du plan.

Utilisation longitudinale. (4a)

Utilisation latérale. (4b)

FINITIONS: blanc - noir.

## Tiroirs (5)

Système LEGRABOX, avec rebords latéraux et arrière en métal peint en couleur noir mat.

Fond en mélaminé noir.

Façade tiroirs internes en mélaminé finition caisson.

## Panneau d'extrémité (6)

Réalisées selon les finitions disponibles, épaisseur 23 mm.

Chanfrein sur chant avant et supérieur.

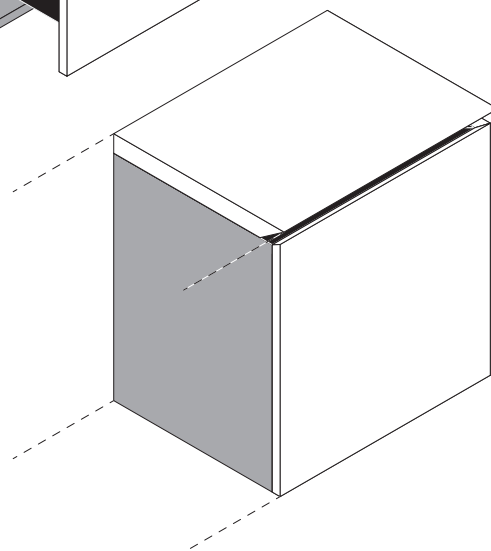
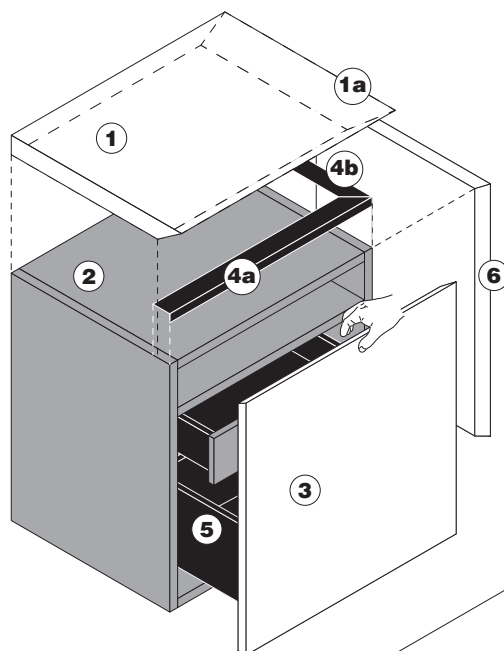

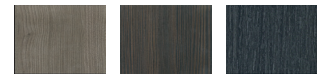

606  
Orme (effet  
pores  
ouverts)

610  
Mélèze  
thermique  
(effet pores  
ouverts)

608  
Chêne  
graphite  
(effet pores  
ouverts)

FINITION FAÇADES COULEURS / ESSENCES

EASYLAK+

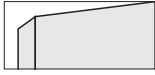

506  
Blanc Cortina

507  
Gris Leeds

SILCOLAK

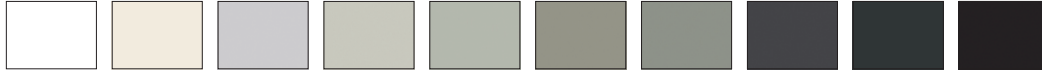
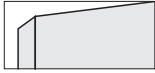

521  
Blanc Sibérie

523  
Hûître

524  
Gris Luton

525  
Gravier

526  
Foin

527  
Corde

528  
Limon

529  
Ardoise

530  
Noir abysse

531  
Noir intense

ECOLAK

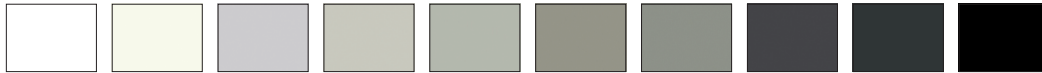
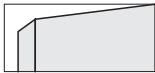

510  
Blanc arctique

129  
Magnolia

513  
Nuage

024  
Galet

512  
Avoine

025  
Ecrû

023  
Boue

515  
Basalte

517  
Charbon

027  
Noir

LASERMAT

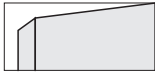

183  
Blanc Kos

178  
Blanc Malè

179  
Beige Luxor

187  
Beige Arizona

184  
Gris Efeso

202  
Gris Antrim

181  
Gris Londra

185  
Gris Bromo

203  
Bleu Fes

188  
Vert Comodoro



186  
Cacao  
Orinoco

182  
Noir Ingo

189  
Rouge Jaipur

BOIS

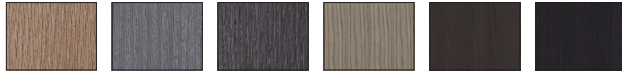
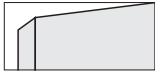

049  
Chêne

033  
Chêne cendré  
gris

076  
Chêne  
graphite

334  
Ecowood Xilo  
2.0 Planked  
Sand (18.22)

335  
Ecowood Xilo  
2.0 Planked  
Grey (18.23)

333  
Ecowood Xilo  
2.0 Striped  
Black (18.04)

POLYESTER

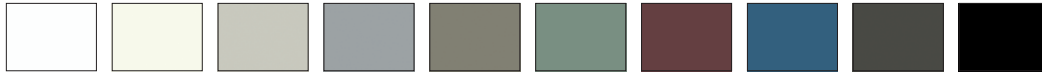

003  
Blanc

129  
Magnolia

024  
Galet

005  
Gris RAL  
7038

063  
Sable

113  
Vert caligo

107  
Rouge Petra

117  
Bleu Jodhpur

004  
Gris

027  
Noir

BOIS SELECTION

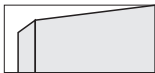

337  
Orme  
Américain

048  
Cœur de  
noyer

093  
Noyer  
"canaletto"  
U.S.

101  
Chêne fumé

METALS

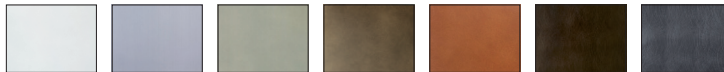

198  
Blanc

934  
Aluminium

197  
Zinc+

195  
Laiton Vintage

196  
Cuivre+

191  
Plomb

192  
Titane

CORIAN®



173  
Blanc

# B14

FINITIONS RÉALISABLES - MEUBLES

CAISSON MÉLAMINÉ



606  
Orme (effet  
pores  
ouverts)



610  
Mélèze  
thermique  
(effet pores  
ouverts)



608  
Chêne  
graphite  
(effet pores  
ouverts)

FINITION FAÇADES COULEURS / ESSENCES

## BOIS MASSIF

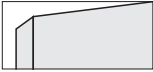

058  
Noyer LIGHT  
canaletto  
"effet scié"



057  
Sapin  
"antique" gris



066  
Orme  
Américain SW



067  
Frêne olivier  
thermotraité SW



102  
Chêne teinté  
fumé SW

## BOIS EXCLUSIVE

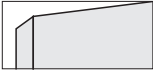

077  
Fossil oak



SUR PLAN  
d'appui



SUR PLAN à  
encastrer



SOUS PLAN  
à encastrer



AFFLEURANT  
moulé

FINITION PLANS

COULEURS / ESSENCES

LAVABOS

CRISTALPLANT® - H 50 mm

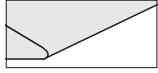

Blanc

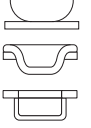

LASERMAT - H 20 mm



183  
Blanc Kos



178  
Blanc Malè



179  
Beige Luxor



187  
Beige Arizona



184  
Gris Efeso



181  
Gris Londra



202  
Gris Antrim



185  
Gris Bromo



203  
Bleu Fes



188  
Vert  
Comodoro



186  
Cacao  
Orinoco



182  
Noir Ingo



189  
Rouge Jaipur

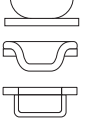

PIERRE - MARBRE - GRANITE - H 20 mm

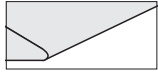

240  
Marbre blanc  
Carrara



250  
Pierre Serena



257  
Quartzite  
Silver



199  
Granite  
Noir Absolu  
Zimbabwe



261  
Marbre  
Emperador  
Dark



254  
Granite Black  
Cosmic



259  
Quartzite  
Calacatta



260  
Marbre Grey  
Stone



266  
Marbre blanc  
Carrara  
Lithoverde®



265  
Marbre Gris  
du Marais  
Lithoverde®



267  
Pietra d'Avola  
Lithoverde®

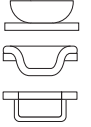

COMPOSITE DEKTON® - H 50 mm



455  
Beige Edora



453  
Noir Sirius



454  
Blanc Zenith



451  
Gris Strato



459  
Marron  
Galema



461  
Domoos



462  
Keranium



460  
Kelya

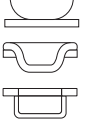

COMPOSITE MDI - H 50 mm



233  
Blanc



234  
Chameau



236  
Vison



237  
Gris



238  
Noir



231  
Devon



232  
Surrey

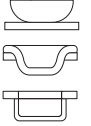

# B14

Design Norbert Wangen

Modulares System aus Hänge-Unterschrank, Zwischen- oder Endelementen, ohne Griff, mit Griffleiste unter der Waschtischplatte.  
Die obere abgeschrägte Kante der Tür, die Griffleiste unterhalb der Waschtischplatte und die umlaufende Abkantung der Waschtischplatte erleichtern das Öffnen der Tür.

## Waschtischplatte (1)

Waschtischplatte hervorgehoben durch abgewinkelte Kanten an 1 oder mehreren Seiten, je nach Plan.

Seitenbearbeitung 35°. (Unterabschrägung). (1a)

STÄRKE: 50 mm.

TIEFE: 505 mm.

KOMPATIBLE WASHBECKEN: Aufsatz-, Einbau- von oben und Unterbaubecken.

## Schrank (2)

Aus Paneelen aus Spanplatte, Stärke 19 mm, wasserabweisend, mit geringem Formaldehydgehalt (zertifiziert Klasse E1, CARB P2 / TSCA Title VI), mit Melaminharzbeschichtung mit hoher Dichte. Vordere und rückseitige Kante aus ABS in Ausführung.

SEITENTEIL HÖHE: 300 - 635 mm ( beide sind kompatibel mit Einbaubecken von oben / Unterbaubecken / flächenbündigen formgepressten Waschbecken Boffi).

SEITENTEIL TIEFE: 470 mm.

TIEFE MIT FRONTPANEEL: 495 mm.

ELEMENTENBREITE: 300 - 450 - 600 - 900 - 1200 mm.

## Türen und Frontpaneele (3)

In Ausführung, Stärke 23 mm, mit oberer Abschrägung (Tür Typ BN).

An Frontpaneelen von Abschluss-Unterschrank und Abschlusspaneelen zusätzlich vertikale Abschrägung an der Seite.

## Griffleiste unter Waschtischplatte (4)

Aus lackiertem Aluminium, vorgesehen zwischen Waschtischplatte und Tür an allen Seiten der abgewinkelten Waschtischplatte.

Längsseitige Verwendung. (4a)

Seitliche Verwendung. (4b)

AUSFÜHRUNGEN: weiß - schwarz.

## Schubladen (5)

System LEGRABOX, mit rückseitiger Blende und Seitenblenden aus mattschwarz lackiertem Metall.

Boden mit Melaminharzbeschichtung schwarz.

Frontpaneele der Innenschubladen mit Melaminbeschichtung Ausführung Schrankelement.

## Abschlusspaneel (6)

In Ausführung, St. 23 mm.

Abschrägung an Vorder- und Oberkante.

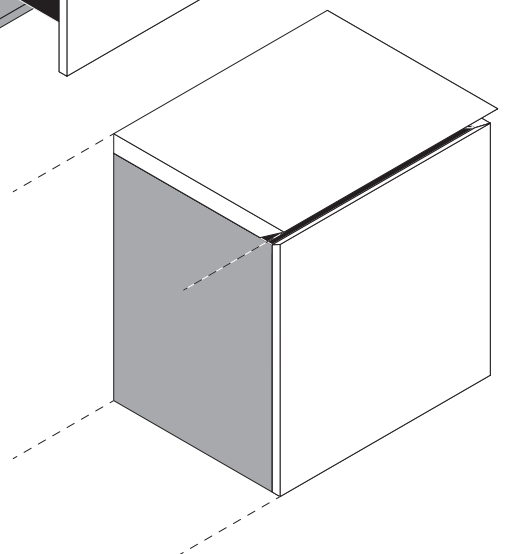
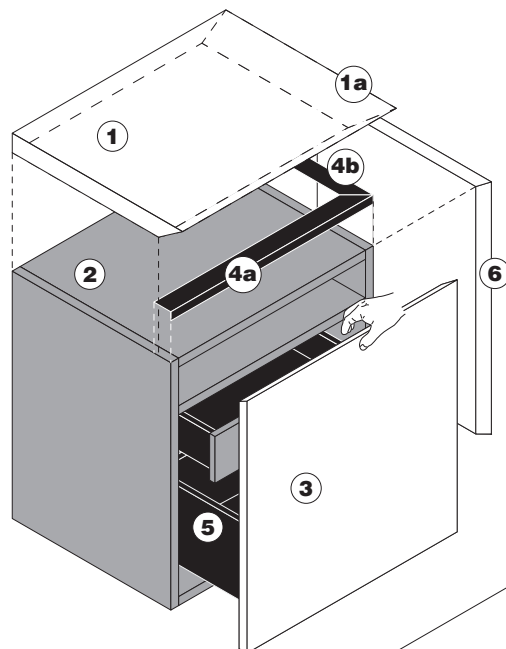

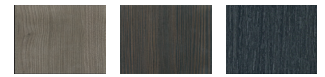

606  
Ulme (Effect  
offenporig)

610  
Thermoholz  
Lärche (Effect  
offenporig)

608  
Eiche  
grafitgrau  
(Effect  
offenporig)

AUSFÜHRUNG  
FRONTEN

FARBEN / HOLZARTEN

EASYLAK+

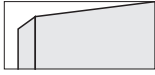

506  
Weiß Cortina

507  
Grau Leeds

SILCOLAK

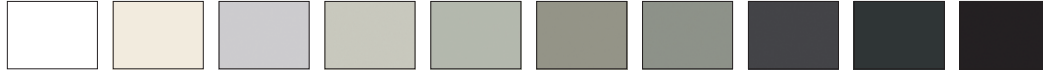
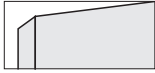

521  
Weiß Sibirien

523  
Perlweiß

524  
Grau Luton

525  
Grau Schotter

526  
Heu

527  
Naturfarben

528  
Schlamm

529  
Ardoise

530  
Völlig schwarz

531  
Tiefschwarz

ECOLAK

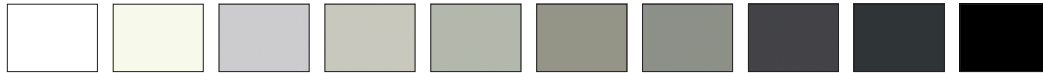
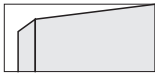

510  
Arktischweiß

129  
Magnolie

513  
Wolkenfarben

024  
Kieselgrau

512  
Haferfarben

025  
Ekrü

023  
Lehm Braun

515  
Basaltgrau

517  
Kohlenschwarz

027  
Schwarz

LASERMAT

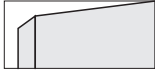

183  
Weiß Kos

178  
Weiß Kos

179  
Beige Luxor

187  
Beige Arizona

184  
Grau Efeso

202  
Grau Antrim

181  
Grau Londra

185  
Grau Bromo

203  
Blue Fes

188  
Grün  
Comodoro



186  
Kakao  
Orinoco

182  
Schwarz Ingo

189  
Rot Jaipur

HOLZ

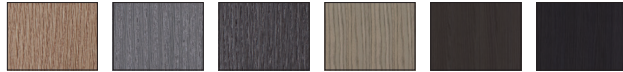
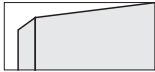

049  
Eiche

033  
Eiche  
Aschgrau

076  
Eiche  
Grafitgrau

334  
Ecowood Xilo  
2.0 Planked  
Sand (18.22)

335  
Ecowood Xilo  
2.0 Planked  
Grey (18.23)

333  
Ecowood Xilo  
2.0 Striped  
Black (18.04)

POLYESTER

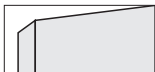

003  
Weiß

129  
Magnolie

024  
Kieselgrau

005  
Grau RAL  
7038

063  
Sandfarben

113  
Grün caligo

107  
Rot Petra

117  
Blue Jodhpur

004  
Grau

027  
Schwarz

HOLZ SELECTION

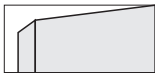

337  
Amerikanische  
Ulme

048  
Kern-  
Nussbaum

093  
Nussbaum  
Canaletto  
U.S.

101  
Räuhereiche

METALS

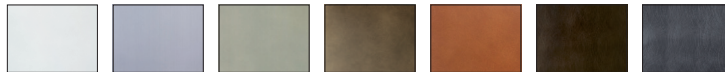

198  
Weiß

934  
Aluminium

197  
Zink+

195  
Messing  
Vintage

196  
Kupfer+

191  
Blei

192  
Titan

CORIAN®



173  
Weiß

# B14

ERHÄLTICHE AUSFÜHRUNGEN - ELEMENTE

MELAMINBESCHICHTETES  
SCHRANKELEMENT



606  
Ulme (Effekt  
offenporig)



610  
Thermoholz  
Lärche (Effekt  
offenporig)



608  
Eiche  
grafitgrau  
(Effekt  
offenporig)

AUSFÜHRUNG  
FRONTEN

FARBEN / HOLZARTEN

MASSIVHOLZ

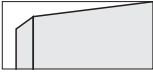

059  
Nussbaum LIGHT Caneletto  
Stageschnitt



057  
„Antikes“  
Tannenholz  
grau



066  
Amerikanische  
Ulme SW



067  
Thermo-  
Olivesche SW



102  
Räuchereiche  
gebeizt SW

HOLZ EXCLUSIVE



077  
Fossil oak



AUFSATZBECKEN



EINBAUBECKEN  
von oben



UNTERBAUBECKEN



FLÄCHENBÜNDIG  
formgepresst

AUSFÜHRUNG

WASCHTISCHPLATTEN FARBEN / HOLZARTEN

WASCHBECKEN

CRISTALPLANT® - H 50 mm

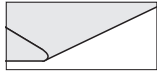

Weiß

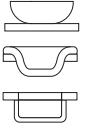

LASERMAT - H 20 mm

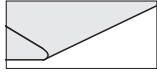

183  
Weiß Kos



178  
Weiß Kos



179  
Beige Luxor



187  
Beige Arizona



184  
Grau Efeso



181  
Grau Londra



202  
Grau Antrim



185  
Grau Bromo



203  
Blue Fes



188  
Grün  
Comodoro



186  
Kakao  
Orinoco



182  
Schwarz Ingo



189  
Rot Jaipur

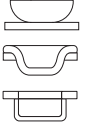

STEIN - MARMOR - GRANIT - H 20 mm

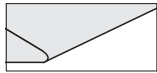

240  
Carrara-  
Marmor weiß



250  
Stein Serena



257  
Quarzit Silver



199  
Granit  
Tiefschwarz  
Zimbabwe



261  
Marmor  
Emperador  
Dark



254  
Granit Black  
Cosmic



259  
Quarzit  
Calacatta



260  
Marmor Grey  
Stone



266  
Marmor  
weiß Carrara  
Lithoverde®



265  
Marmor Gris  
du Marais  
Lithoverde®



267  
Stein Pietra  
D'Avola  
Lithoverde®

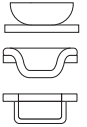

AGGLOMERAT DEKTON® - H 50 mm

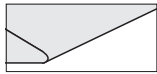

455  
Beige Edora



453  
Schwarz  
Sirius



454  
Weiß Zenith



451  
Grau Strato



459  
Braun Galema



461  
Domoos



462  
Keranium



460  
Kelya

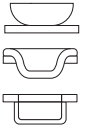

AGGLOMERAT MDI - H 50 mm

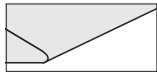

233  
Weiß



234  
Kamel



236  
Nerz



237  
Grau



238  
Schwarz



231  
Devon



232  
Surrey

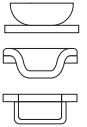



# B14

Design Norbert Wangen

Sistema modular de muebles contenedores bajos suspendidos para uso intermedio o terminal, sin tirador, con perfil tirador bajo la encimera.

La empuñadura para abrir la puerta se obtiene gracias al chaflán superior de la puerta misma en combinación con el perfil tirador bajo encimera y el chaflán perimetral de la encimera.

## Encimera (1)

Encimera caracterizada por chaflanes inclinados a la vista en uno o varios lados, dependiendo del proyecto.

Cabecera lateral inclinada en 35°. (Bisel inferior). (1a)

GROSOR: 50 mm.

PROFUNDIDAD: 505 mm.

LAVABOS COMPATIBLES: sobre encimera apoyado, sobre encimera empotrado y bajo encimera empotrado.

## Contenedor (2)

Realizados en paneles de partículas de madera grosor 19 mm, hidrófugos, con bajo contenido de formaldehído (certificado clase E1, CARB P2/ TSCA Title VI) melamínico con papeles con alto gramaje tratados con resinas melamínicas. Borde delantero y trasero en ABS del mismo color.

ALTURA COSTADO: 300 - 635 mm (ambas compatibles con lavabos Boffi sobre encimera empotrados / bajo encimera empotrados / enrasados a la encimera moldeados).

PROFUNDIDAD COSTADO: 470 mm.

PROFUNDIDAD CON FRENTE: 495 mm.

ANCHURA MÓDULO: 300 - 450 - 600 - 900 - 1200 mm.

## Puertas y frentes (3)

Realizadas en acabado, grosor 23 mm con chaflán superior (tipo puerta BN).

En traseras de bases a uso terminal y paneles terminal chaflán añadido lateral vertical.

## Perfil tirador bajo encimera (4)

Realizado en aluminio pintado, está prevista entre encimera y puerta a lo largo de todos los lados achaflanados de la encimera.

Uso longitudinal. (4a)

Uso lateral. (4b)

ACABADOS: blanco - negro.

## Cajones (5)

Sistema LEGRABOX, con bordes laterales y posteriores en metal lacado en color negro mate.

Fondo de madera ennoblecida negra.

Frente cajones internos en madera ennoblecida acabado mueble contenedor.

## Panel terminal (6)

Realizado en acabado, grosor 23 mm.

Chaflán en el borde frontal y superior.

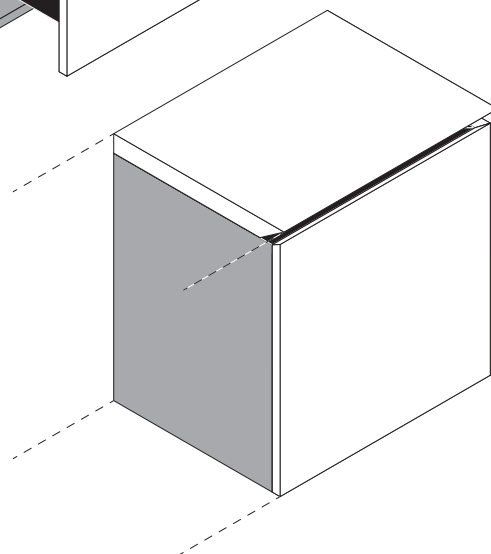
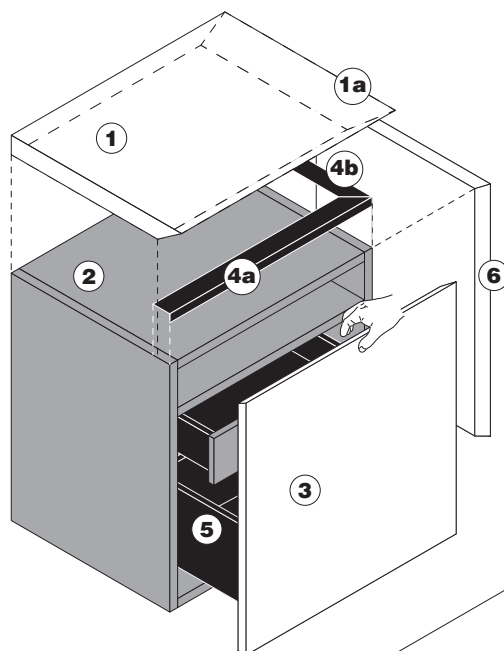



606  
Olmo (efecto  
poro abierto)

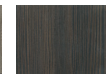

610  
Alerce  
término  
(efecto poro  
abierto)



608  
Roble grafito  
(efecto poro  
abierto)

ACABADO  
FRENTES

COLORES / MADERAS

EASYLAK+

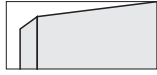

506  
Blanco  
Cortina



507  
Gris Leeds

SILCOLAK

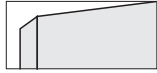

521  
Blanco  
Siberia



523  
Ostra



524  
Gris Luton



525  
Grava



526  
Heno



527  
Cuerda



528  
Limo



529  
Pizarra



530  
Negro Abismo



531  
Negro Intenso

ECOLAK

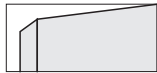

510  
Blanco ártico



129  
Magnolia



513  
Nube



024  
Guijarro



512  
Avena



025  
Crudo



023  
Fango



515  
Basalto



517  
Carbón



027  
Negro

LASERMAT

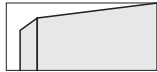

183  
Blanco Kos



178  
Blanco Malè



179  
Beige Luxor



187  
Beige Arizona



184  
Gris Efeso



202  
Gris Antrim



181  
Gris Londra



185  
Gris Bromo



203  
Azul Fes



188  
Verde  
Comodoro



186  
Cacao  
Orinoco



182  
Negro Ingo



189  
Rojo Jaipur

MADERA

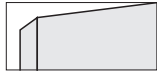

049  
Roble



033  
Roble ceniza



076  
Roble grafito



334  
Ecowood Xilo  
2.0 Planked  
Sand (18.22)



335  
Ecowood Xilo  
2.0 Planked  
Grey (18.23)



333  
Ecowood Xilo  
2.0 Striped  
Black (18.04)

POLIÉSTER

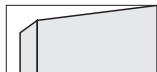

003  
Blanco



129  
Magnolia



024  
Guijarro



005  
Gris RAL  
7038



063  
Arena



113  
Verde caligo



107  
Rojo Petra



117  
Azul Jodhpur



004  
Gris



027  
Negro

MADERA SELECTION

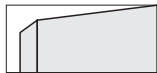

337  
Olmo  
americano



048  
Alma de  
nogal



093  
Nogal canaletto  
(americano)  
U.S.



101  
Roble  
ahumado

METALS



198  
Blanco



934  
Aluminium



197  
Zink+



195  
Latón Vintage



196  
Cobre+



191  
Plomo



192  
Titanio

CORIAN®



173  
Blanco

# B14

ACABADOS REALIZABLES - MUEBLES

MUEBLE  
CONTENEDOR  
ENNOBLECIDO.



606  
Olmo (efecto  
poro abierto)



610  
Alerce  
térmico  
(efecto poro  
abierto)



608  
Roble grafito  
(efecto poro  
abierto)

ACABADO  
FRENTEROS

COLORES / MADERAS

## MADERA MACIZA



058  
Nogal LIGHT  
canaletto  
"corte sierra"



057  
Abeto  
"antiguo" gris



066  
Olmo  
americano  
SW



067  
Fresno Olivato  
termotratado SW



102  
Roble teñido  
ahumado SW

## MADERA EXCLUSIVE



077  
Fossil oak



SOBRE  
ENCIMERA  
apoyado



SOBRE  
ENCIMERA  
empotrado



BAJO  
ENCIMERA  
empotrado



ENRASADO  
A LA  
ENCIMERA  
moldeado

ACABADO  
ENCIMERAS

COLORES / MADERAS

LAVABOS

CRISTALPLANT® - H 50 mm

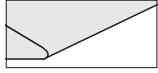

Blanco

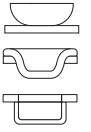

LASERMAT - H 20 mm



183  
Blanco Kos



178  
Blanco Malé



179  
Beige Luxor



187  
Beige Arizona



184  
Gris Efeso



181  
Gris Londra



202  
Gris Antrim



185  
Gris Bromo



203  
Azul Fes



188  
Verde  
Comodoro



186  
Cacao  
Orinoco



182  
Negro Ingo



189  
Rojo Jaipur

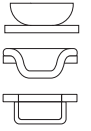

PIEDRA - MÁRMOL - GRANITO - H 20 mm

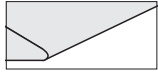

240  
Mármol  
blanco  
Carrara



250  
Piedra Serena



257  
Cuarcita Silver



199  
Granito Negro  
Absoluto  
Zimbabwe



261  
Mármol  
Emperador  
Dark



254  
Granito Black  
Cosmic



259  
Cuarcita  
Calacatta



260  
Mármol Grey  
Stone



266  
Mármol blanco  
Carrara  
Lithoverde®



265  
Mármol Gris  
du Marais  
Lithoverde®



267  
Pietra d'Avola  
Lithoverde®

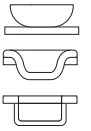

COMPUESTO DEKTON® - H 50 mm



455  
Beige Edora



453  
Negro Sirius



454  
Blanco Zenith



451  
Gris Strato



459  
Marrón  
Galema



461  
Domoos



462  
Keranium



460  
Kelya

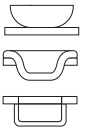

COMPUESTO MDI - H 50 mm



233  
Blanco



234  
Camello



236  
Visón



237  
Gris



238  
Negro



231  
Devon



232  
Surrey

