

I FIUMI ST

Design Claudio Silvestrin

Sistema modulare di contenitori base sospesi senza maniglia.

Gli smussi superiori a 45° di frontali e pannelli terminali consentono di ospitare il piano, anch'esso con smussi a 45° su 3 lati (una volta alloggiato il piano, non si vede lo spessore che resta "annegato" tra gli smussi dei mobili).

Impugnatura per apertura cassetto dalla parte inferiore del frontale.

I contenitori base sono disponibili in versione da appoggio o sospesi. Non è possibile realizzare contenitori provvisti di maniglia.

Piano (1)

Realizzato con smusso a 45° su 3 lati per consentirne l'accosto a scomparsa sugli smussi superiori dei mobili.

SPESORE: 20 mm

PROFONDITÀ: 531 mm

LAVABI COMPATIBIL: soprapiano da appoggio / soprapiano da incasso / sottopiano da incasso / filopiano stampato.

Contenitore (2)

Realizzato nella stessa finitura dei frontali.

SILCOLAK: in pannelli di particelle di legno MDF medium density spessore 19 mm laccato texturizzato fine opaco.

LEGNO: in pannelli di particelle di legno MDF medium density spessore 19 mm impiallacciati con tranciato di legno spessore 0,6 mm, bordo legno spessore 1 mm.

ALTEZZA FIANCO: 400 mm (compatibili con lavabi soprapiano da appoggio / soprapiano da incasso / sottopiano da incasso / filopiano stampato).

PROFONDITÀ FIANCO: 530 mm.

PROFONDITÀ CON FRONTALE: 530 mm.

LARGHEZZA MODULO: 600 - 900 mm.

Ante e frontali (3)

Spessore 19 mm realizzata in pannello di particelle di legno MDF medium density laccato texturizzato fine opaco (SILCOLAK) o impiallacciato con tranciato di legno spessore 0,6 mm con bordo legno spessore 1 mm (LEGNO).

Con smusso a 45° su tutti i lati. Impugnatura per apertura cassetto dalla parte inferiore del frontale.

Cassetti (4)

Sistema LEGRABOX, con spondine laterali e posteriore in metallo verniciato in colore nero opaco. Fondo in nobilitato nero.

Frontale cassetti interni in finitura contenitore.

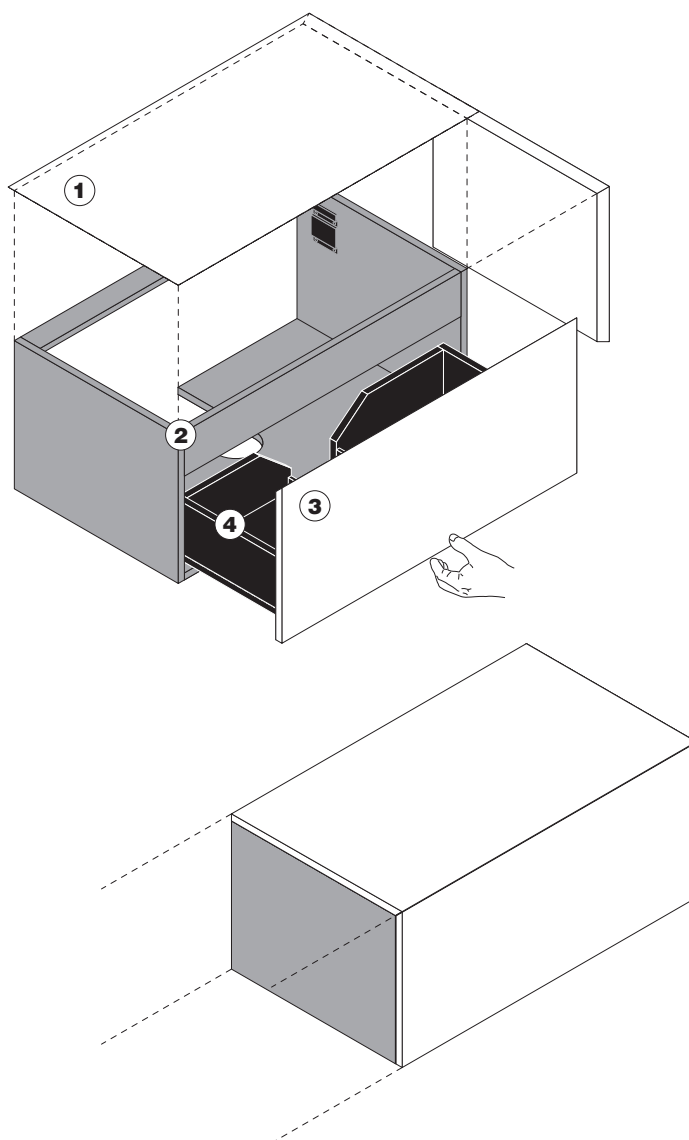

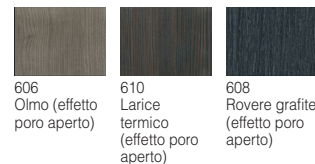

FINITURA FRONTALI
E CONTENITORI COLORI / ESSENZE

SILCOLAK

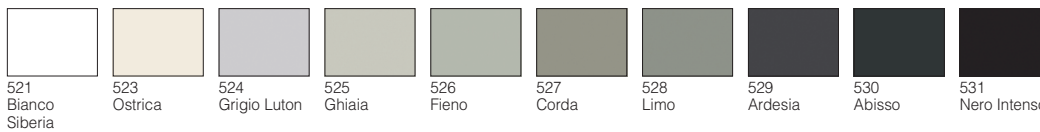
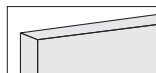

521 Bianco Siberia 523 Ostrica 524 Grigio Luton 525 Ghiaia 526 Fieno 527 Corda 528 Limo 529 Ardesia 530 Abisso 531 Nero Intenso

LEGNO



049 Rovere 033 Rovere cenere 076 Rovere grafite 334 Ecowood Xilo 2.0 Planked Sand (18.22) 335 Ecowood Xilo 2.0 Planked Grey (18.23) 333 Ecowood Xilo 2.0 Striped Black (18.04)

LEGNO SELECTION



337 Olmo americano 048 Noce colore 093 Noce canaletto U.S. 101 Rovere affumicato



SOPRAPIANO
da appoggio



SOPRAPIANO
da incasso



SOTTOPIANO
da incasso



FILOPIANO
stampato

FINITURA PIANI COLORI / ESSENZE

LAVABI

CRISTALPLANT® - H 20 mm

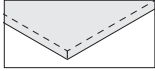

Bianco

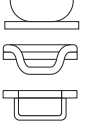

CORIAN® - H 20 mm

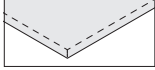

173
Bianco



PIETRA - MARMO - GRANITO - H 20 mm

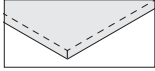

240
Marmo bianco
Carrara



250
Pietra Serena



199
Granito Nero
Assoluto
Zimbabwe



257
Quartzite
Silver



261
Marmo
Emperador
Dark



271
Granito
Bohemian
Grey



254
Granito Black
Cosmic



259
Quartzite
Calacatta



275
Quartzite Sky
Gold



260
Marmo Grey
Stone



272
Marmo Gris
du Marais



273
Pietra d'Avola



274
Pietra Crema
d'Orcia.



266
Marmo bianco
Carrara
Lithoverde®



265
Marmo Gris
du Marais
Lithoverde®



267
Pietra d'Avola
Lithoverde®

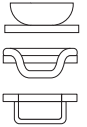

COMPOSITO DEKTON® - H 20 mm

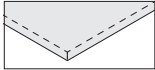

455
Beige Edora



453
Nero Sirius



454
Bianco Zenith



451
Grigio Strato



457
Grigio Ventus



458
Grigio Korus



459
Marrone
Galema



461
Domoos



462
Keranium



460
Kelya

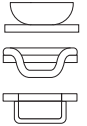

COMPOSITO MDI - H 20 mm

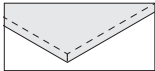

231
Devon



232
Surrey

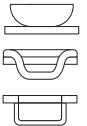

I FIUMI ST

Design Claudio Silvestrin

Wall hung, modular base units without handle.

The 45° angled sections of front and end panels house the top, which has 45° edges on 3 side (the cabinet edges cover the top thickness).

The drawer can be opened through the lower side of the front.

Base units can be wall hung or floor-mounted. Units with handle are not available.

Top (1)

Tops have 45° edges on 3 sides, to match upper edges of front and end panels in finish, in order to make the top thickness not visible.

THICKNESS: 20 mm

DEPTH: 531 mm

COMPATIBLE WASHBASINS: top-mounted / built-in / under-mounted / moulded flush-mounted.

Unit (2)

Made of in the same finish as front panels.

SILCOLAK: MDF medium density fibres board, 19 mm. thick, matt fine lacquered textured.

WOOD: made of 19 mm thick MDF medium density fibres board, veneered with 0,6 mm thick wood veneer; 1 mm thick wood edge.

SIDE PANEL HEIGHT: 400 mm (compatible with top-mounted, built-in, under-mounted and moulded flush-mounted washbasins).

SIDE PANEL DEPTH: 530 mm.

DEPTH INCLUDING DOOR: 530 mm.

MODULE WIDTH: 600 - 900 mm.

Doors and front panels (3)

Thickness 19 mm in MDF medium density wood particle panels, matt lacquered, fine textured (SILCOLAK) or veneered with 0,6 mm thick wood veneer, with 1 mm thick wood edge (WOOD).

45° edges on all sides. The drawer can be opened through the lower side of the front.

Drawers (4)

LEGRABOX series with sides and back in varnished matt black metal. Bottom in black melamine.

Front of internal drawers in same finish as carcass.

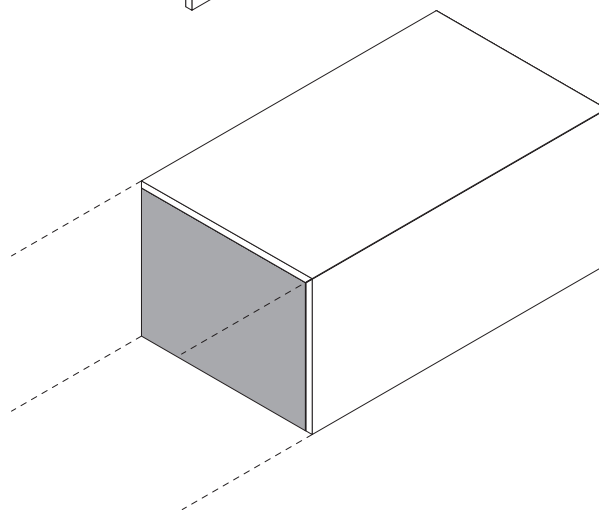
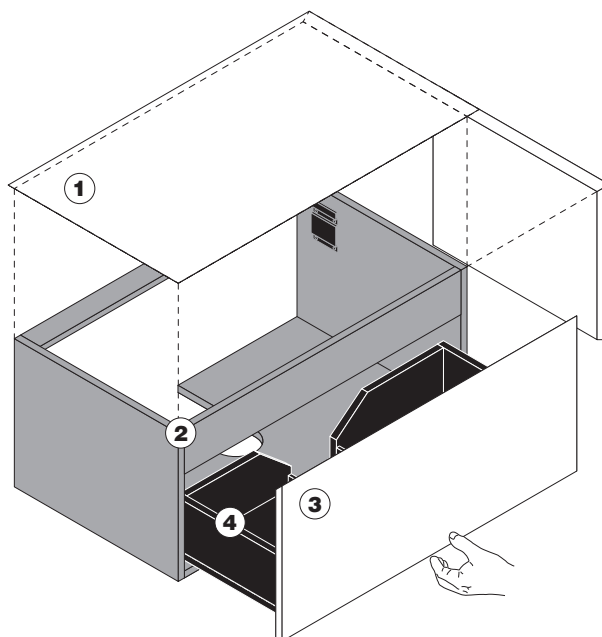



606
Elm (open-
pore effect)



610
Thermo-
treated larch
wood (open
pore effect)



608
Grey-graphite
oak (open
pore effect)

FRONT PANEL AND
UNIT FINISH

COLOURS / SPECIES

SILCOLAK



521
Siberia white



523
Oyster-pearl



524
Luton grey



525
Gravel grey



526
Hay



527
Rope-colour



528
Silt



529
Slate grey



530
Abyss black



531
Jet black

WOOD

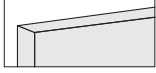

049
Oak



033
Ash-grey oak



076
Grey-graphite
oak



334
Ecowood Xilo
2.0 Planked
Sand (18.22)



335
Ecowood Xilo
2.0 Planked
Grey (18.23)



333
Ecowood Xilo
2.0 Striped
Black (18.04)

WOOD SELECTION

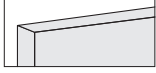

337
American elm



048
Core walnut



093
Canaletto
walnut U.S.



101
Smoked oak



TOPS FINISH COLOURS / SPECIES

WASHBASINS

CRISTALPLANT® - H 20 mm

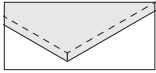

White

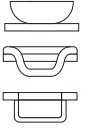

CORIAN® - H 20 mm

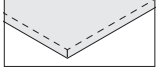

173
White



STONE - MARBLE - GRANITE - H 20 mm

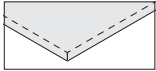

240
White Carrara
marble



250
Serena stone



199
Absolute black
Zimbabwe
granite



257
Quartzite
Silver



261
Emperador
Dark marble



271
Bohemian
Grey granite



254
Black Cosmic
granite



259
Quartzite
Calacatta



275
Quartzite Sky
Gold



260
Grey Stone
marble



272
Gris du
Marais marble



273
Pietra d'Avola
stone



274
Crema
d'Orcia stone.



266
White Carrara
marble
Lithoverde®



265
Gris du
Marais marble
Lithoverde®



267
Pietra
d'Avola stone
Lithoverde®

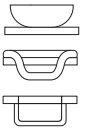

COMPOSITE DEKTON® - H 20 mm

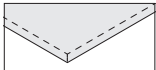

455
Edora beige



453
Sirius black



454
Zenith white



451
Strato grey



457
Ventus grey



458
Korus grey



459
Galema
brown



461
Domoos



462
Keranium



460
Kelya

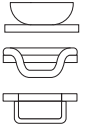

COMPOSITE MDI - H 20 mm

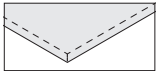

231
Devon



232
Surrey

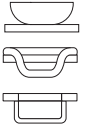

I FIUMI ST

Design Claudio Silvestrin

Système modulaire de bases suspendues sans poignée.

Les chanfreins supérieurs à 45° de façades et panneaux d'extrémité permettent de recevoir le plan, lui aussi avec chanfreins à 45° sur 3 côtés (une fois le plan logé, l'épaisseur qui reste "noyée" entre les chanfreins des meubles ne se voit pas).

Prise de main pour ouverture tiroir de la partie inférieure de la façade.

Les caissons base sont disponibles en version d'appui ou suspendus. Il n'est pas possible de réaliser des caissons avec poignée.

Plan (1)

Réalisé avec chanfrein à 45° sur tous les côtés pour permettre la juxtaposition escamotable sur les chanfreins supérieurs des meubles.

ÉPAISSEUR: 20 mm

PROFONDEUR: 531 mm

LAVABOS COMPATIBLES: sur plan d'appui / sur plan à encastrer / sous plan à encastrer / affleurant moulé.

Caisson (2)

Réalisé dans la finition des façades.

SILCOLAK: en panneaux de particules de bois MDF medium density épaisseur 19 mm laqué avec texture fine mate.

BOIS: en panneaux de particules de bois MDF medium density épaisseur 19 mm plaqués avec bois tranché épaisseur 0,6 mm, chant bois épaisseur 1 mm.

HAUTEUR CÔTÉ: 400 mm (compatibles avec lavabos sur plan d'appui / sur plan à encastrer / sous plan à encastrer / affleurants moulés).

PROFONDEUR CÔTÉ: 530 mm.

PROFONDEUR AVEC FAÇADE: 530 mm.

LARGEUR MODULE: 600 - 900 mm.

Portes et façades (3)

Épaisseur 19 mm réalisé en panneau de particules de bois MDF medium density laqué avec texture fine mate (SILCOLAK) ou plaqué avec bois tranché épaisseur 0,6 mm avec chant bois épaisseur 1 mm (BOIS).

Avec chanfrein à 45° sur tous les côtés. Prise de main pour ouverture tiroir de la partie inférieure de la façade.

Tiroirs (4)

Système LEGRABOX, avec rebords latéraux et arrière en métal peint en couleur noir mat. Fond en mélaminé noir.

Façade tiroirs internes finition caisson.

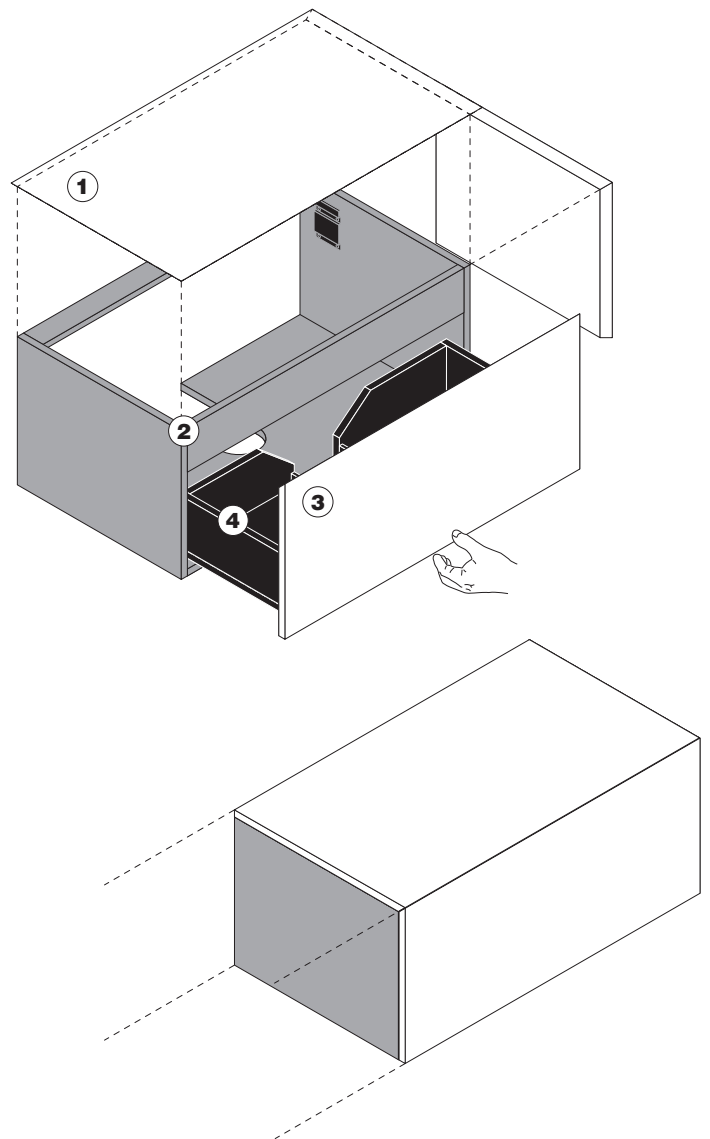



606
Orme (effet
pores
ouverts)

610
Mélèze
thermique
(effet pores
ouverts)

608
Chêne
graphite
(effet pores
ouverts)

FINITION FAÇADES
ET CAISSONS

COULEURS / ESSENCES

SILCOLAK



521
Blanc Sibérie



523
Hûître



524
Gris Luton



525
Gravier



526
Foin



527
Corde



528
Limon



529
Ardoise



530
Noir abysse



531
Noir intense

BOIS



049
Chêne



033
Chêne cendré
gris



076
Chêne
graphite



334
Ecowood Xilo
2.0 Planked
Sand (18.22)



335
Ecowood Xilo
2.0 Planked
Grey (18.23)



333
Ecowood Xilo
2.0 Striped
Black (18.04)

BOIS SELECTION



337
Orme
Américain



048
Cœur de
noyer



093
Noyer
"canaletto"
U.S.



101
Chêne fumé



SUR PLAN
d'appui



SUR PLAN à
encastrer



SOUS PLAN
à encastrer



AFFLEURANT
moulé

FINITION PLANS COULEURS / ESSENCES

LAVABOS

CRISTALPLANT® - H 20 mm

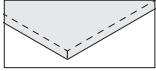

Blanc

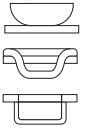

CORIAN® - H 20 mm

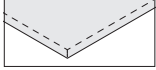

173
Blanc



PIERRE - MARBRE - GRANITE - H 20 mm

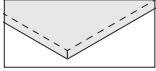

240
Marbre blanc
Carrara



250
Pierre Serena



199
Granite
Noir Absolu
Zimbabwe



257
Quartzite
Silver



261
Marbre
Emperador
Dark



271
Granite
Bohemian
Gris



254
Granite Black
Cosmic



259
Quartzite
Calacatta



275
Quartzite Sky
Gold



260
Marbre Grey
Stone



272
Marbre Gris
du Marais



273
Pietra d'Avola



274
Pierre Crema
d'Orcia.



266
Marbre blanc
Carrara
Lithoverde®



265
Marbre Gris
du Marais
Lithoverde®



267
Pietra d'Avola
Lithoverde®

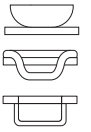

COMPOSITE DEKTON® - H 20 mm

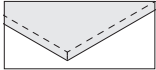

455
Beige Edora



453
Noir Sirius



454
Blanc Zenith



451
Gris Strato



457
Gris Ventus



458
Gris Korus



459
Marron
Galema



461
Domoos



462
Keranium



460
Kelya

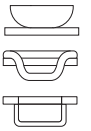

COMPOSITE MDI - H 20 mm

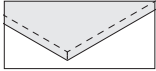

231
Devon



232
Surrey

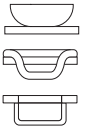

I FIUMI ST

Design Claudio Silvestrin

Modulares System aus Hänge-Unterschrank ohne Griffe.
45° gewinkelte Front- und Abschlusspaneel ermöglichen den Einsatz der ebenfalls an drei Seiten 45° gewinkelten Waschtischplatte (nachdem diese zwischen den Abkantungen des Möbels "versenkt" wurde, ist deren Stärke nicht sichtbar).
Die Öffnung der Schublade erfolgt am unteren Teil des Frontpaneels.
Die Unterschranke sind als Hänge- oder Standelemente erhältlich. Griffe sind an diesen Schränken nicht möglich.

Waschtischplatte (1)

Aus an 3 Seiten 45° gewinkelter Platte, um den Einsatz zwischen den oberen Abkantungen des Möbels zu ermöglichen.

STÄRKE: 20 mm

TIEFE: 531 mm

KOMPATIBLE WASHBECKEN: Aufsatz-/ Einbau- von oben, /Unterbau- /und flächenbündige formgepresste Waschbecken.

Schrank (2)

In der gleichen Ausführung wie die Frontpaneel.

SILCOLAK: aus mattlackierten MDF-Faserplatten Stärke 19 mm mit feiner Textur.
HOLZ: aus MDF-Faserplatten Stärke 19 mm mit Holz furnier Stärke 0,6 mm, Holz kante Stärke 1 mm.

SEITENTEIL HÖHE: 400 mm (kompatibel mit Aufsatzbecken, Einbaubecken von oben, Unterbaubecken und flächenbündigen formgepressten Waschbecken).

SEITENTEIL TIEFE: 530 mm.

TIEFE MIT FRONTPANEEL: 530 mm.

TIEFUND MIT FRONTTEIL: 600 - 900 mm.

Türen und Frontpaneel (3)

Stärke 19 mm, Paneel aus MDF-Holzspanplatten, matt lackiert, fein texturiert (SILCOLAK), oder Holz furnier Stärke 0,6 mm mit Holz kante Stärke 1 mm (HOLZ).
Mit 45° Kante an allen Seiten. Die Öffnung der Schublade erfolgt am unteren Teil der Frontpaneel.

Schubladen (4)

System LEGRABOX, mit rückseitiger Blende und Seitenblenden aus mattschwarz lackiertem Metall. Boden schwarze Melaminbeschichtung.
Frontpaneel der Innenschubladen Ausführung Schrankelement.

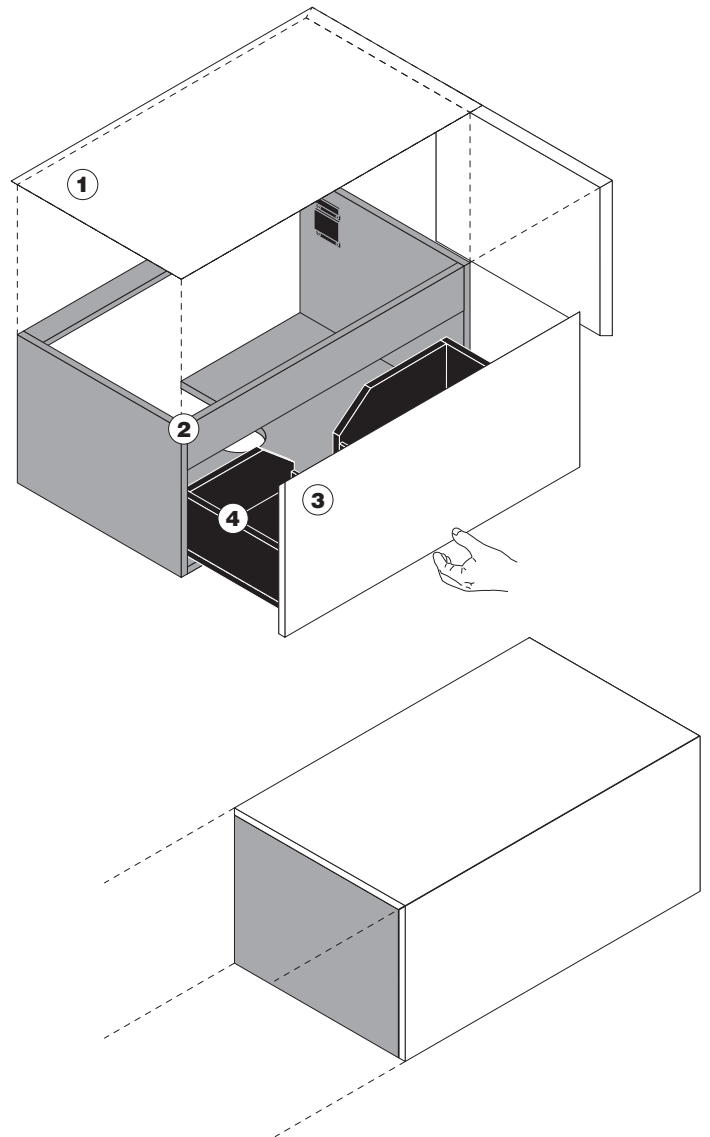

I FIUMI ST

ERHÄLTICHE AUSFÜHRUNGEN - ELEMENTE

MELAMINBESCHICHTETES
SCHRANKELEMENT

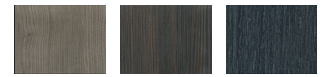

606
Ulme (Effekt
offenporig)

610
Thermoholz
Lärche (Effekt
offenporig)

608
Eiche
grafitgrau
(Effekt
offenporig)

AUSFÜHRUNG FRONTEN
UNDSCHRANKELEMENTE FARBEN / HOLZARTEN

SILCOLAK

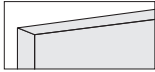

521
Weiß Sibirien



523
Perlweiß



524
Grau Luton



525
Grau Schotter



526
Heu



527
Naturfarben



528
Schlamm



529
Ardoise



530
Völlig schwarz



531
Tiefschwarz

HOLZ

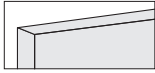

049
Eiche



033
Eiche
Aschgrau



076
Eiche
Grafitgrau



334
Ecowood Xilo
2.0 Planked
Sand (18.22)



335
Ecowood Xilo
2.0 Planked
Grey (18.23)



333
Ecowood Xilo
2.0 Striped
Black (18.04)

HOLZ SELECTION

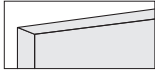

337
Amerikanische
Ulme



048
Kern-
Nussbaum



093
Nussbaum
Canaletto
U.S.



101
Räuchereiche



AUFSATZBECKEN



EINBAUBECKEN
von oben



UNTERBAUBECKEN



FLÄCHENBÜNDIG
formgepresst

AUSFÜHRUNG

WASCHTISCHPLATTEN FARBEN / HOLZARTEN

WASCHBECKEN

CRISTALPLANT® - H 20 mm

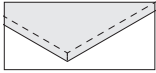

Weiß

CORIAN® - H 20 mm

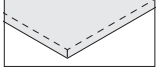

173
Weiß

STEIN - MARMOR - GRANIT - H 20 mm

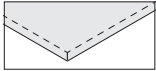

240
Carrara-
Marmor weiß



250
Stein Serena



199
Granit
Tiefschwarz
Zimbabwe



257
Quartzit Silver



261
Marmor
Emperador
Dark



271
Granit
Bohemian
Grey



254
Granit Black
Cosmic



259
Quartzit
Calacatta



275
Quartzit Sky
Gold



260
Marmor Grey
Stone



272
Marmor Gris
du Marais



273
Stein Pietra
D'Avola



274
Stein Crema
d'Orcia.



266
Marmor
weiß Carrara
Lithoverde®



265
Marmor Gris
du Marais
Lithoverde®



267
Stein Pietra
D'Avola
Lithoverde®

AGGLOMERAT DEKTON® - H 20 mm

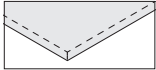

455
Beige Edora



453
Schwarz
Sirius



454
Weiß Zenith



451
Grau Strato



457
Grau Ventus



458
Grau Korus



459
Braun Galema



461
Domoos



462
Keranium



460
Kelya

AGGLOMERAT MDI - H 20 mm

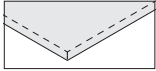

231
Devon



232
Surrey

I FIUMI ST

Design Claudio Silvestrin

Sistema modular de contenedores bases suspendidos sin tirador.

Los biselos superiores a 45° de frontales y paneles terminales permiten de incluir el top, eso tambien con biselos a 45° en los 3 lados (una vez puesto el top, no se ve el grosor que queda "ahogado" entre los biselos de los muebles).

Empuñadura para abrir el cajon en la parte inferior del frontal.

Los contenedores base estan disponibles en version de apoyo o suspendidos. No es posible realizar contenedores con tirador.

Top (1)

Realizada con chaflán a 45° en 3 lados para consentir su adosado escamoteable en los chaflanes superiores de los muebles.

ESPESOR: 20 mm.

PROFUNDIDAD: 531 mm.

LAVABOS COMPATIBLES: sobretop de apoyo / sobretop de encaje / bajotop de encaje / filotop moldeado.

Contenedor (2)

Elaborado en el mismo acabado de los frentes.

SILCOLAK: en paneles de particulas de madera MDF medium density grosor 19 mm lacado texturizado fine mate.

MADERA: de paneles de particulas de madera MDF, medium density de 19 mm de espesor chapados con chapas de madera de 0,6 mm de espesor, borde de madera de 1 mm de espesor.

ALTURA COSTADO: 400 mm (compatibles con lavabos sobre encimera apoyados, sobre encimera empotrados, bajo encimera empotrados y enrasados a la encimera moldeados).

PROFUNDIDAD COSTADO: 530 mm.

PROFUNDIDAD CON FRENTE: 530 mm.

ANCHURA MÓDULO: 600 - 900 mm.

Puertas y frontales (3)

Grosor 19 mm realizado en panel de particulas de madera MDF medium density lacado texturizado fine mate (SILCOLAK) o chapado con chapa de madera grosor 0,6 mm con borde en madera grosor 1 mm (MADERA).

Con biselo a 45° en todos los lados. Empuñadura para abrir el cajon en la parte inferior del frontal.

Cajones (4)

Sistema LEGRABOX, con bordes laterales y posteriores en metal lacado en color negro mate. Fondo en melaminico negro.

Frontal cajones internos en acabado contenedor.

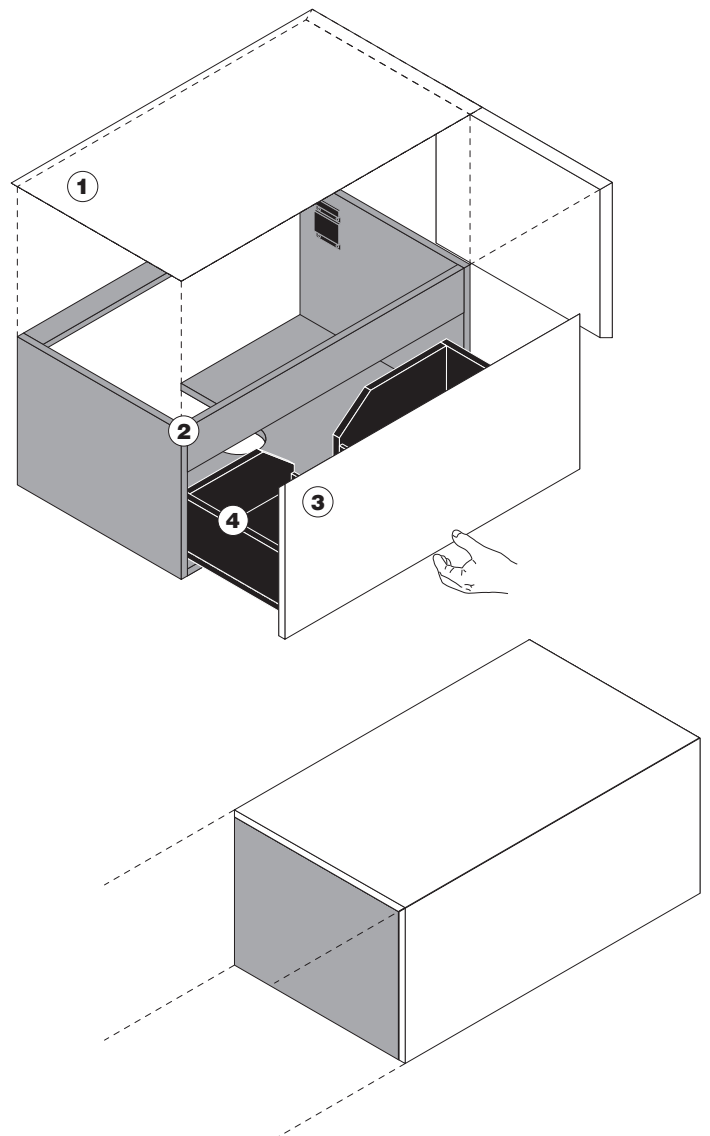



606
Olmo (efecto
poro abierto)



610
Alerce
termico (
efecto poro
abierto)



608
Roble grafito
(efecto poro
abierto)

ACABADO FRONTALES
Y CONTENEDORES COLORES / MADERAS

SILCOLAK



521
Blanco
Siberia



523
Ostra



524
Gris Luton



525
Grava



526
Heno



527
Cuerda



528
Limo



529
Pizarra



530
Negro Abismo



531
Negro Intenso

MADERA



049
Roble



033
Roble ceniza



076
Roble grafito



334
Ecowood Xilo
2.0 Planked
Sand (18.22)



335
Ecowood Xilo
2.0 Planked
Grey (18.23)



333
Ecowood Xilo
2.0 Striped
Black (18.04)

MADERA SELECTION

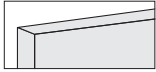

337
Olmo
americano



048
Alma de
nogal



093
Nogal canaletto
(americano)
U.S.



101
Roble
ahumado



SOBRE
ENCIMERA
apoyado



SOBRE
ENCIMERA
empotrado



BAJO
ENCIMERA
empotrado



ENRASADO
A LA
ENCIMERA
moldeado

ACABADO ENCIME-
RAS

COLORES / MADERAS

LAVABOS

CRISTALPLANT® - H 20 mm

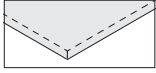

Blanco

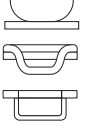

CORIAN® - H 20 mm

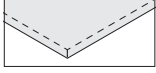

173
Blanco



PIEDRA - MÁRMOL - GRANITO - H 20 mm

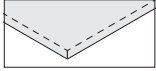

240
Mármol
blanco
Carrara



250
Piedra Serena



199
Granito Negro
Absoluto
Zimbabwe



257
Cuarcita Silver



261
Mármol
Emperador
Dark



271
Granito
Bohemina
Grey



254
Granito Black
Cosmic



259
Cuarcita
Calacatta



275
Cuarcita Sky
Gold



260
Mármol Grey
Stone



272
Mármol Gris
du Marais



273
Pietra d'Avola



274
Piedra Crema
d'Orcia.



266
Mármol blanco
Carrara
Lithoverde®



265
Mármol Gris
du Marais
Lithoverde®



267
Pietra d'Avola
Lithoverde®

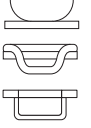

COMPUESTO DEKTON® - H 20 mm

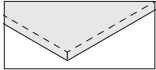

455
Beige Edora



453
Negro Sirius



454
Blanco Zenith



451
Gris Strato



457
Gris Ventus



458
Gris Korus



459
Marrón
Galema



461
Domoos



462
Keranium



460
Kelya

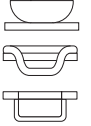

COMPUESTO MDI - H 20 mm

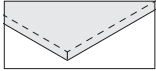

231
Devon



232
Surrey

