

# Programma SIMPLE

Design Piero Lissoni + C.R.S. Boffi

Sistema modulare di contenitori base / colonna sospesi dotati di sistema di apertura automatica a pressione "tip-on". Non è possibile realizzare contenitori provvisti di maniglia.

## Piano (1)

Piano squadrato allestibile con lavabi sopra piano da appoggio, sopra piano da incasso, sottopiano da incasso o filopiano stampato.

SPESSORE: 12 - 15 - 20 - 23 mm.

PROFONDITÀ: 500 mm.

## Contenitore (2)

Realizzato in pannelli di particelle di legno di spessore 19 mm, idrofughi, a basso contenuto di formaldeide (certificato classe E1, CARB P2 / TSCA Title VI) nobilitato con carte ad alta grammatura trattate con resine melamminiche. Bordo anteriore e posteriore in ABS in tinta.

ALTEZZA FIANCO: 300 - 470 mm (entrambe compatibili con incasso di lavabi Boffi sopra piano da incasso / sottopiano da incasso / filopiano stampato).

PROFONDITÀ FIANCO: 470 mm.

PROFONDITÀ CON FRONTALE: 495 mm.

LARGHEZZA MODULO: 300 - 450 - 600 - 900 - 1200 mm.

## Fianco in finitura (3)

Su ogni composizione vengono realizzati, senza sovrapprezzo, i fianchi esterni terminali in finitura (considerare che per i mobili con frontali in Corian® il fianco finito sarà in Ecolak bianco / per mobili con frontali in Legno 3D il fianco sarà in impiallacciato liscio, senza effetto-listoni).

Il fianco in finitura comprende anche la finitura del bordo verticale a vista (escluso Lasermat).

Il fianco in finitura NON è realizzabile in LEGNO MASSELLO (anche nelle versioni 3D / FREEHAND / SHADES). Per queste finiture è necessario ordinare separatamente i pannelli terminali.

## Cassetti (4)

Sistema LEGRABOX, con spondine laterali e posteriore in metallo verniciato in colore nero opaco. Fondo in nobilitato nero. Frontale cassetti interni in nobilitato finitura contenitore.

## Ante e frontali (5)

Realizzate in finitura, spessore 23 mm, con apertura automatica "tip-on".

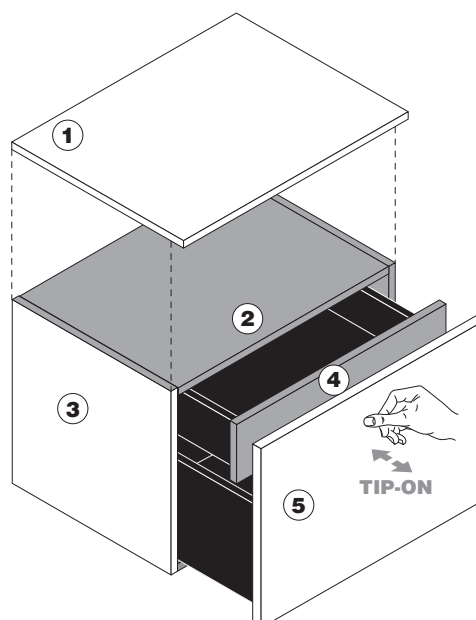

# Programma SIMPLE

FINITURE REALIZZABILI - MOBILI

CONTENITORE  
NOBILITATO



606  
Olmo (effetto  
poro aperto)



610  
Larice  
termico  
(effetto poro  
aperto)



608  
Rovere grafite  
(effetto poro  
aperto)

FINITURA  
FRONTALI

COLORI / ESSENZE

EASYLAK+

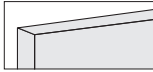

506  
Bianco  
Cortina



507  
Grigio Leeds

LASERMAT

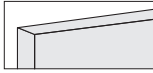

183  
Bianco Kos



178  
Bianco Malè



179  
Beige Luxor



187  
Beige Arizona



184  
Grigio Efeso



202  
Grigio Antrim



181  
Grigio Londra



185  
Grigio Bromo



203  
Blu Fes



188  
Verde  
Comodoro



186  
Cacao  
Orinoco



182  
Nero Ingo



189  
Rosso Jaipur

SILCOLAK

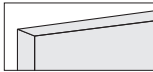

521  
Bianco  
Siberia



523  
Ostrica



524  
Grigio Luton



525  
Ghiaia



526  
Fieno



527  
Corda



528  
Limo



529  
Ardesia



530  
Abisso



531  
Nero Intenso

ECOLAK

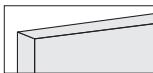

510  
Bianco artico



129  
Magnolia



513  
Nuvola



024  
Ciottolo



512  
Avena



025  
Ecrù



023  
Fango



515  
Basalto



517  
Carbone



027  
Nero

LEGNO

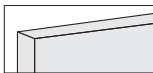

049  
Rovere



033  
Rovere  
cenere



076  
Rovere grafite



334  
Ecowood Xilo  
2.0 Planked  
Sand (18.22)



335  
Ecowood Xilo  
2.0 Planked  
Grey (18.23)



333  
Ecowood Xilo  
2.0 Striped  
Black (18.04)

POLIESTERE

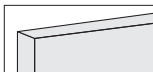

003  
Bianco



129  
Magnolia



005  
Grigio RAL  
7038



024  
Ciottolo



063  
Sabbia



107  
Rosso Petra



117  
Blu Jodhpur



113  
Verde caligo



004  
Grigio



027  
Nero

LEGNO SELECTION

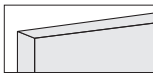

337  
Olmo  
americano



048  
Noce colore



093  
Noce  
canaletto U.S.



101  
Rovere  
affumicato

METALS



198  
Bianco



934  
Aluminium



197  
Zinco+



195  
Ottone  
Vintage



196  
Rame+



192  
Titanio



191  
Piombo

CORIAN®



173  
Bianco

# Programma SIMPLE

FINITURE REALIZZABILI - MOBILI

CONTENITORE  
NOBILITATO



606  
Olmo (effetto  
poro aperto)



610  
Larice  
termico  
(effetto poro  
aperto)



608  
Rovere grafite  
(effetto poro  
aperto)

FINITURA  
FRONTALI

COLORI / ESSENZE

## LEGNO 3D

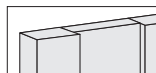

049  
Rovere



033  
Rovere  
cenere



076  
Rovere grafite



337  
Olmo  
americano



048  
Noce colore



334  
Ecowood Xilo  
2.0 Planked  
Sand (18.22)



335  
Ecowood Xilo  
2.0 Planked  
Grey (18.23)



333  
Ecowood Xilo  
2.0 Striped  
Black (18.04)



093  
Noce  
canaletto U.S.



101  
Rovere  
affumicato

## LEGNO MASSELLO



058  
Noce LIGHT  
canaletto  
"taglio sega"



057  
Abete "antico"  
grigio



066  
Olmo  
americano  
SW



067  
Frassino olivato  
termotrattato SW



102  
Rovere tinto  
affumicato  
SW

## LEGNO MASSELLO 3D

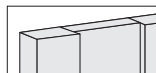

058  
Noce LIGHT  
canaletto  
"taglio sega"



057  
Abete "antico"  
grigio



066  
Olmo  
americano  
SW



067  
Frassino olivato  
termotrattato SW



102  
Rovere tinto  
affumicato  
SW

## LEGNO MASSELLO FREEHAND



061  
Noce LIGHT  
canaletto



066  
Olmo  
americano  
SW



067  
Frassino olivato  
termotrattato SW



102  
Rovere tinto  
affumicato  
SW

## LEGNO MASSELLO SHADES

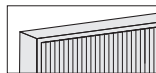

061  
Noce LIGHT  
canaletto



066  
Olmo  
americano  
SW



067  
Frassino olivato  
termotrattato SW



102  
Rovere tinto  
affumicato  
SW

## LEGNO EXCLUSIVE

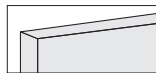

077  
Abonos fossil  
oak

# Programma SIMPLE

FINITURE REALIZZABILI - PIANI

TIPOLOGIE LAVABI



SOPRAPIANO  
da appoggio



SOPRAPIANO  
da incasso



SOTTOPIANO  
da incasso



FILOPIANO  
stampato

FINITURA PIANI

COLORI / ESSENZE

LAVABI

VETRO EXTRALIGHT SABBIAATO VERNICIATO - H 12 mm

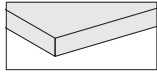

818  
Bianco



816  
Tortora



817  
Caffè



VETRO EXTRALIGHT ACIDATO VERNICIATO - H 12 mm

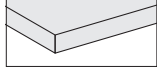

818  
Bianco



816  
Tortora

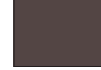

817  
Caffè



CRISTALPLANT® - H 15 mm

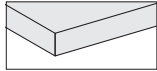

Bianco



LASERMAT - H 20 mm

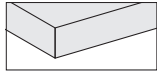

183  
Bianco Kos



178  
Bianco Malè



179  
Beige Luxor



187  
Beige Arizona

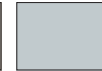

184  
Grigio Efeso

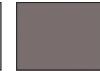

181  
Grigio Londra

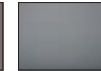

202  
Grigio Antrim



185  
Grigio Bromo

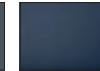

203  
Blu Fes

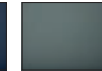

188  
Verde  
Comodoro



186  
Cacao  
Orinoco



182  
Nero Ingo

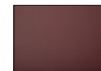

189  
Rosso Jaipur



CORIAN® - H 20 mm

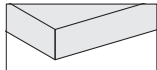

173  
Bianco



PIETRA - MARMO - GRANITO - H 20 mm

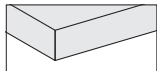

240  
Marmo bianco  
Carrara



250  
Pietra Serena



257  
Quarzite  
Silver



199  
Granito Nero  
Assoluto  
Zimbabwe

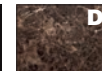

261  
Marmo  
Emperador  
Dark

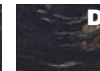

254  
Granito Black  
Cosmic



259  
Quarzite  
Calacatta



260  
Marmo Grey  
Stone



273  
Pietra d'Avola



274  
Pietra Crema  
d'Orcia



266  
Marmo bianco  
Carrara  
Lithoverde®



265  
Marmo Gris  
du Marais  
Lithoverde®



267  
Pietra d'Avola  
Lithoverde®



COMPOSITO DEKTON® - H 20 mm

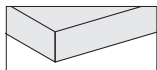

455  
Beige Edora



453  
Nero Sirius

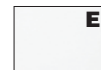

454  
Bianco Zenith



451  
Grigio Strato



459  
Marrone  
Galema



461  
Domoos

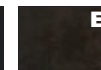

462  
Keranium



460  
Kelya



COMPOSITO MDI - H 12 mm

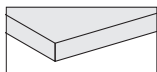

233  
Bianco



234  
Cammello



236  
Visone



237  
Grigio



238  
Nero



231  
Devon



232  
Surrey



# Programma SIMPLE

FINITURE REALIZZABILI - PIANI

TIPOLOGIE LAVABI



SOPRAPIANO  
da appoggio



SOPRAPIANO  
da incasso



SOTTOPIANO  
da incasso



FILOPIANO  
stampato

FINITURA PIANI

COLORI / ESSENZE

LAVABI

LEGNO MASSELLO - H 23 mm

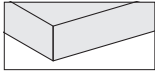

058  
Noce LIGHT  
canaletto  
"taglio sega"



057  
Abete "antico"  
grigio



066  
Olmo  
americano  
SW



067  
Frassino olivato  
termotrattato SW



102  
Rovere tinto  
affumicato  
SW



# Programma SIMPLE

Design Piero Lissoni + C.R.S. Boffi

Wall hung, modular base/tall units with TIP-ON push-opening mechanism. Units with handle are not feasible.

## Top (1)

The square-edged tops can be fitted with top-mounted, built-in, under-mounted or moulded flush-mounted washbasins.

THICKNESS: 12 - 15 - 20 - 23 mm.

DEPTH: 500 mm

## Unit (2)

It's made of 19 mm thick wood particle board panels, waterproof, with low formaldehyde emission (class E1, CARB P2 / TSCA Title VI certified), treated with high performance melamine resin. Front and back edges in ABS, same colour

SIDE PANEL HEIGHT: 300 - 470 mm (both compatible with built-in / under-mounted / moulded flush-mounted Boffi washbasins).

SIDE PANEL DEPTH: 470 mm.

DEPTH INCLUDING DOOR: 495 mm.

MODULE WIDTH: 300 - 450 - 600 - 900 - 1200 mm.

## Finished side panel (3)

The visible side panels of all compositions are finished, without an extra charge (please note that front panels in Corian® have finished side panels in white Ecolak and front panels in Wood 3D have finished side panels in wood veneer - without 3D effect).

The finished side panel includes the finishing of the frontal vertical edge too (Lasermat excluded).

The finished side panel IS NOT FEASIBLE in SOLID WOOD (also in 3D / FREEHAND / SHADES versions). For these finishes please order the end panels separately.

## Drawers (4)

LEGRABOX series with sides and back in varnished matt black metal. Bottom in black melamine. Front of internal drawers in melamine, same finish as carcass.

## Doors and front panels (5)

Finished, thickness 23 mm, with TIP-ON push-opening mechanism.

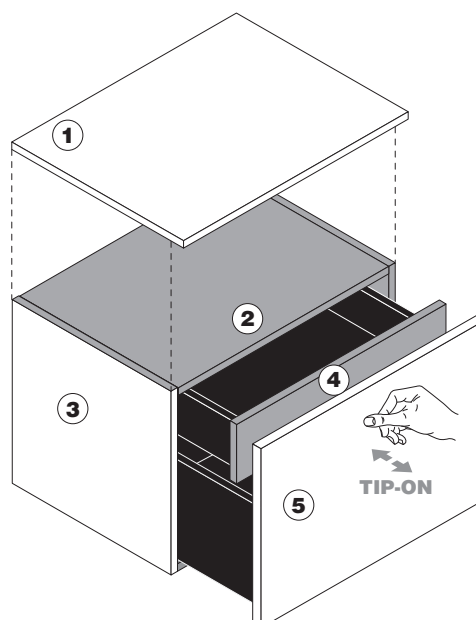

# Programma SIMPLE

FEASIBLE FINISHES - CABINETS

MELAMINE-COATED  
CARCASS

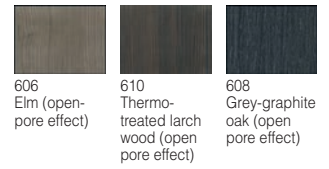

FRONT PANELS  
FINISH

COLOURS / SPECIES

## EASYLAK+

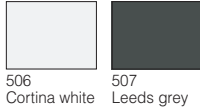

506 Cortina white  
507 Leeds grey

## LASERMAT



183 Kos white  
178 Malè white  
179 Luxor beige  
187 Arizona beige  
184 Efeso grey  
202 Antrim grey  
181 Londra grey  
185 Bromo grey  
203 Fes blue  
188 Comodoro green



186 Orinoco cocoa  
182 Ingo black  
189 Jaipur red

## SILCOLAK

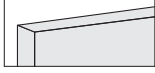

521 Siberia white  
523 Oyster-pearl  
524 Luton grey  
525 Gravel grey  
526 Hay  
527 Rope-colour  
528 Silt  
529 Slate grey  
530 Abyss black  
531 Jet black

## ECOLAK

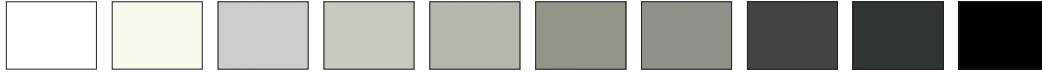
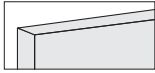

510 Arctic white  
129 Magnolia  
513 Cloud colour  
024 Pebble grey  
512 Oat colour  
025 Ecrú  
023 Mud  
515 Basalt grey  
517 Charcoal  
027 Black

## WOOD

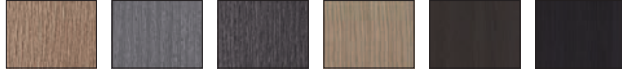

049 Oak  
033 Ash-grey oak  
076 Grey-graphite oak  
334 Ecowood Xilo 2.0 Planked Sand (18.22)  
335 Ecowood Xilo 2.0 Planked Grey (18.23)  
333 Ecowood Xilo 2.0 Striped Black (18.04)

## POLYESTER

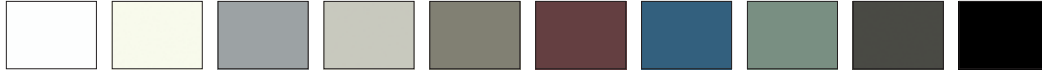
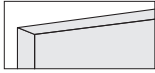

003 White  
129 Magnolia  
005 Grey RAL 7038  
024 Pebble grey  
063 Sand  
107 Petra red  
117 Jodhpur blue  
113 Caligo green  
004 Grey  
027 Black

## WOOD SELECTION

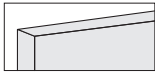

337 American elm  
048 Core walnut  
093 Canaletto walnut U.S.  
101 Smoked oak

## METALS

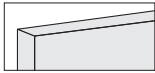

198 White  
934 Aluminium  
197 Zinc+  
195 Vintage brass  
196 Copper+  
192 Titanium  
191 Lead

## CORIAN®

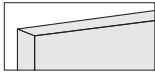

173 White

# Programma SIMPLE

FEASIBLE FINISHES - CABINETS

MELAMINE-COATED  
CARCASS

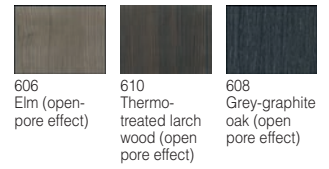

FRONT PANELS  
FINISH

COLOURS / SPECIES

## WOOD 3D

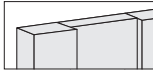

## SOLID WOOD

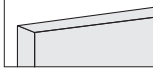

## SOLID WOOD 3D (Price: SOLID WOOD + 10%)

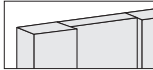

## SOLID WOOD FREEHAND



## SOLID WOOD SHADES



## WOOD EXCLUSIVE

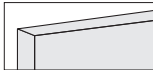



# Programma SIMPLE

FEASIBLE FINISHES - TOPS

WASHBASIN  
TYPOLOGIES



TOP-  
MOUNTED



BUILT-IN



UNDER-  
MOUNTED



moulded  
FLUSH-  
MOUNTED

TOPS FINISH

COLOURS / SPECIES

WASHBASINS

## SANDED PAINTED EXTRALIGHT GLASS - H 12 mm

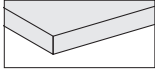

818  
White



816  
Dove grey



817  
Coffee



## FROSTED PAINTED EXTRALIGHT GLASS - H 12 mm

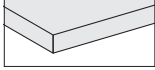

818  
White



816  
Dove grey



817  
Coffee



## CRISTALPLANT® - H 15 mm

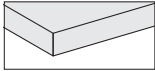

White



## LASERMAT - H 20 mm

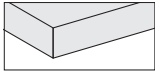

183  
Kos white



178  
Malè white

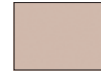

179  
Luxor beige



187  
Arizona beige



184  
Efeso grey



181  
Londra grey



202  
Antrim grey



185  
Bromo grey



203  
Fes blue



188  
Comodoro  
green



186  
Orinoco  
cocoa



182  
Ingo black

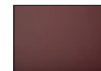

189  
Jaipur red



## CORIAN® - H 20 mm

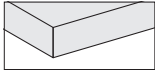

173  
White



## STONE - MARBLE - GRANITE - H 20 mm

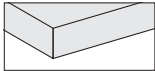

240  
White Carrara  
marble



250  
Serena stone



257  
Quartzite  
Silver



199  
Absolute black  
Zimbabwe  
granite



261  
Emperador  
Dark marble



254  
Black Cosmic  
granite



259  
Quartzite  
Calacatta



260  
Grey Stone  
marble



273  
Pietra d'Avola  
stone



274  
Pietra Crema  
d'Orcia stone



266  
White Carrara  
marble  
Lithoverde®



265  
Gris du  
Marais marble  
Lithoverde®



267  
Pietra  
d'Avola stone  
Lithoverde®



## DEKTON® COMPOSITE - H 20 mm

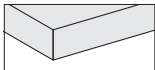

455  
Edora beige



453  
Sirius black



454  
Zenith white



451  
Strato grey



459  
Galema  
brown



461  
Domoos



462  
Keranium



460  
Kelya



## MDI COMPOSITE - H 12 mm

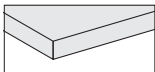

233  
White



234  
Camel



236  
Mink



237  
Grey



238  
Black



231  
Devon



232  
Surrey



# Programma SIMPLE

FEASIBLE FINISHES - TOPS

WASHBASIN  
TYPOLOGIES



TOP-  
MOUNTED



BUILT-IN



UNDER-  
MOUNTED



moulded  
FLUSH-  
MOUNTED

TOPS FINISH

COLOURS / SPECIES

WASHBASINS

SOLID WOOD - H 23 mm

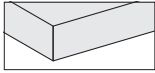

058  
LIGHT Canaletto  
walnut, "sawn"  
effect



057  
"Old" grey  
pinewood



066  
American elm  
SW



067  
Thermo-treated  
Olivato ash  
wood SW



102  
Smoked dyed  
oak SW



# Programma SIMPLE

Design Piero Lissoni + C.R.S. Boffi

Système modulaire de bases / armoires suspendues dotées de système d'ouverture par pression "tip-on". Il n'est pas possible de réaliser des caissons munis de poignée.

## Plan (1)

Plan avec chant droit aménageable avec lavabos sur plan d'appui, sur plan à encastrer, sous plan à encastrer ou affleurants moulés.  
ÉPAISSEUR: 12 - 15 - 20 - 23 mm.  
PROFONDEUR: 500 mm.

## Caisson (2)

Réalisé en panneaux de particules de bois d'épaisseur 19 mm, hydrofuges, à faible teneur en formaldéhyde (certifié classe E1 / CARB P2 / TSCA Title VI) mélaminé avec papiers à haute densité traités avec des résines mélaminiques. Chant avant et arrière en ABS de la même couleur.  
HAUTEUR CÔTÉ: 300 - 470 mm (les deux compatibles avec lavabos Boffi sur plan à encastrer / sous plan à encastrer/ affleurants moulés).  
PROFONDEUR CÔTÉ: 470 mm.  
PROFONDEUR AVEC FAÇADE: 495 mm.  
LARGEUR MODULE: 300 - 450 - 600 - 900 - 1200 mm.

## Côté selon finitions disponibles (3)

Sur chaque composition sont réalisés, sans majoration de prix, les côtés d'extrémité selon les finitions disponibles (considérer que pour les meubles avec façades en Corian® le côté fini sera en Ecolak blanc / pour meubles avec façades en Bois 3D le côté sera en bois plaqué lisse, sans lattes juxtaposées des différentes épaisseurs).  
Le côté fini comprend également la finition du chant vertical apparent (sauf Lasermat).  
Le côté fini N'EST PAS réalisable en BOIS MASSIF (également dans les versions 3D / FREEHAND / SHADES). Pour ces finitions il est nécessaire de commander séparément les panneaux d'extrémité.

## Tiroirs (4)

Système LEGRABOX, avec rebords latéraux et arrière en métal peint en couleur noir mat. Fond en mélaminé noir. Façades tiroirs internes en mélaminé finition caisson.

## Portes et façades (5)

Réalisées selon les finitions disponibles, épaisseur 23 mm, avec ouverture automatique "tip-on".

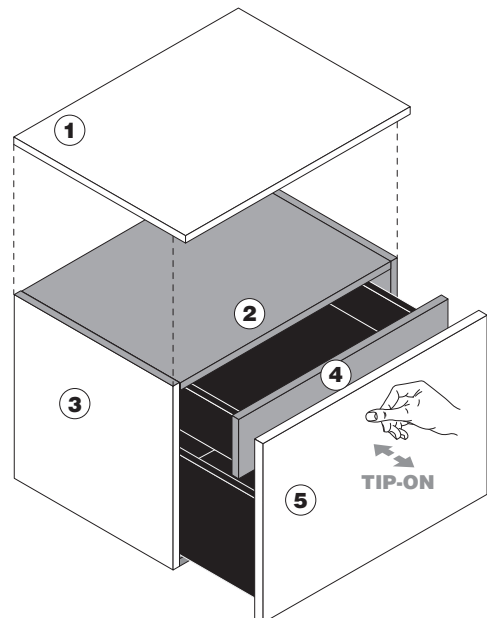

# Programma SIMPLE

FINITIONS RÉALISABLES - MEUBLES

CAISSON MÉLAMINÉ



606  
Orme (effet  
pores  
ouverts)

610  
Mélèze  
thermique  
(effet pores  
ouverts)

608  
Chêne  
graphite  
(effet pores  
ouverts)

## FINITION FAÇADES COULEURS / ESSENCES

### EASYLAK+

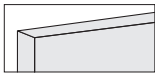

506  
Blanc Cortina

507  
Gris Leeds

### LASERMAT

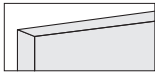

183  
Blanc Kos

178  
Blanc Malè

179  
Beige Luxor

187  
Beige Arizona

184  
Gris Efeso

202  
Gris Antrim

181  
Gris Londra

185  
Gris Bromo

203  
Bleu Fes

188  
Vert  
Comodoro



186  
Cacao  
Orinoco

182  
Noir Ingo

189  
Rouge Jaipur

### SILCOLAK

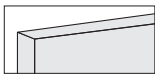

521  
Blanc Sibérie

523  
Hûtre

524  
Gris Luton

525  
Gravier

526  
Foin

527  
Corde

528  
Limon

529  
Ardoise

530  
Noir abysses

531  
Noir intense

### ECOLAK

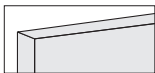

510  
Blanc arctique

129  
Magnolia

513  
Nuage

024  
Galet

512  
Avoine

025  
Écru

023  
Boue

515  
Basalte

517  
Charbon

027  
Noir

### BOIS

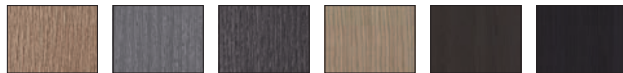
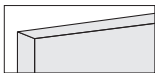

049  
Chêne

033  
Chêne cendré  
gris

076  
Chêne  
graphite

334  
Ecowood Xilo  
2.0 Planked  
Sand (18.22)

335  
Ecowood Xilo  
2.0 Planked  
Grey (18.23)

333  
Ecowood Xilo  
2.0 Striped  
Black (18.04)

### POLYESTER

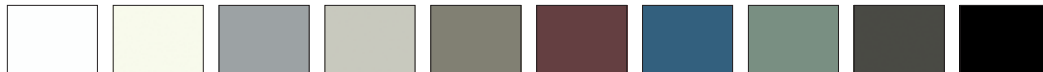

003  
Blanc

129  
Magnolia

005  
Gris RAL  
7038

024  
Galet

063  
Sable

107  
Rouge Petra

117  
Bleu Jodhpur

113  
Vert caligo

004  
Gris

027  
Noir

### BOIS SELECTION

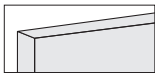

337  
Orme  
Américain

048  
Cœur de  
noyer

093  
Noyer  
"canaletto"  
U.S.

101  
Chêne fumé

### METALS



198  
Blanc

934  
Aluminium

197  
Zinc+

195  
Laiton Vintage

196  
Cuivre+

192  
Titane

191  
Plomb

### CORIAN®



173  
Blanc

# Programma SIMPLE

FINITIONS RÉALISABLES - MEUBLES

CAISSON MÉLAMINÉ

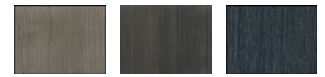

606  
Orme (effet  
pores  
ouverts)

610  
Mélèze  
thermique  
(effet pores  
ouverts)

608  
Chêne  
graphite  
(effet pores  
ouverts)

## FINITION FAÇADES COULEURS / ESSENCES

### BOIS 3D

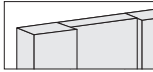

049  
Chêne



033  
Chêne cendré  
gris



076  
Chêne  
graphite



337  
Orme  
Américain



048  
Cœur de  
noyer



334  
Ecowood Xilo  
2.0 Planked  
Sand (18.22)



335  
Ecowood Xilo  
2.0 Planked  
Grey (18.23)



333  
Ecowood Xilo  
2.0 Striped  
Black (18.04)



093  
Noyer  
"canaletto"  
U.S.



101  
Chêne fumé

### BOIS MASSIF

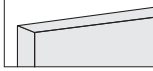

058  
Noyer LIGHT  
canaletto  
"effet scié"



057  
Sapin  
"antique" gris



066  
Orme  
Américain SW



067  
Frêne olivier  
thermotraité SW



102  
Chêne teinté  
fumé SW

### BOIS MASSIF 3D (Prix: BOIS MASSIF + 10%)

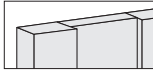

058  
Noyer LIGHT  
canaletto  
"effet scié"



057  
Sapin  
"antique" gris



066  
Orme  
Américain SW



067  
Frêne olivier  
thermotraité SW



102  
Chêne teinté  
fumé SW

### BOIS MASSIF FREEHAND



061  
Noyer LIGHT  
canaletto



066  
Orme  
Américain SW



067  
Frêne olivier  
thermotraité SW



102  
Chêne teinté  
fumé SW

### BOIS MASSIF SHADES



061  
Noyer LIGHT  
canaletto



066  
Orme  
Américain SW



067  
Frêne olivier  
thermotraité SW



102  
Chêne teinté  
fumé SW

### BOIS EXCLUSIVE



077  
Abonos fossil  
oak

# Programma SIMPLE

FINITIONS RÉALISABLES - PLANS

TYPOLOGIES LAVABOS



SUR PLAN  
d'appui



SUR PLAN à  
encastrer



SOUS PLAN  
à encastrer



AFFLEURANT  
moulé

FINITION PLANS

COULEURS / ESSENCES

LAVABOS

## VERRE EXTRALIGHT SABLÉ PEINT - H 12 mm

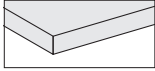

818  
Blanc



816  
Gris  
tourterelle



817  
Café



## VERRE EXTRALIGHT ACIDIFIÉ PEINT - H 12 mm

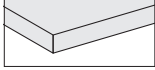

818  
Blanc



816  
Gris  
tourterelle



817  
Café



## CRISTALPLANT® - H 15 mm

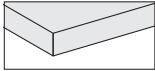

Blanc



## LASERMAT - H 20 mm

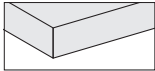

183  
Blanc Kos



178  
Blanc Malé



179  
Beige Luxor



187  
Beige Arizona



184  
Gris Efeso



181  
Gris Londra



202  
Gris Antrim



185  
Gris Bromo



203  
Bleu Fes



188  
Vert  
Comodoro



186  
Cacao  
Orinoco



182  
Noir Ingo



189  
Rouge Jaipur



## CORIAN® - H 20 mm

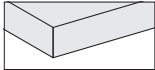

173  
Blanc



## PIERRE - MARBRE - GRANITE - H 20 mm

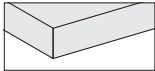

240  
Marbre blanc  
Carrara



250  
Pierre Serena



257  
Quartzite  
Silver



199  
Granite  
Noir Absolu  
Zimbabwe



261  
Marbre  
Emperador  
Dark



254  
Granite Black  
Cosmic



259  
Quartzite  
Calacatta



260  
Marbre Grey  
Stone



273  
Pietra d'Avola



274  
Pierre Crema  
d'Orcia



266  
Marbre blanc  
Carrara  
Lithoverde®



265  
Marbre Gris  
du Marais  
Lithoverde®



267  
Pietra d'Avola  
Lithoverde®



## COMPOSITE DEKTON® - H 20 mm

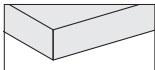

455  
Beige Edora



453  
Noir Sirius



454  
Blanc Zenith



451  
Gris Strato



459  
Marron  
Galema



461  
Domoos



462  
Keranium



460  
Kelya



## COMPOSITE MDI - H 12 mm

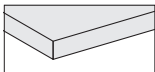

233  
Blanc



234  
Chameau



236  
Vison



237  
Gris



238  
Noir



231  
Devon



232  
Surrey



# Programma SIMPLE

FINITIONS RÉALISABLES - PLANS

TIPOLOGIES LAVABOS



SUR PLAN  
d'appui



SUR PLAN à  
encastrer



SOUS PLAN  
à encastrer



AFFLEURANT  
moulé

FINITION PLANS

COULEURS / ESSENCES

LAVABOS

BOIS MASSIF - H 23 mm

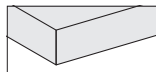

058  
Noyer LIGHT  
canaletto  
"effet scié"



057  
Sapin  
"antique" gris



066  
Orme  
Américain SW



067  
Frêne olivier  
thermotraité SW



102  
Chêne teinté  
fumé SW



# Programma SIMPLE

Design Piero Lissoni + C.R.S. Boffi

Modulsystem mit hängenden Unterschränken / Hochschränken und automatischem Drucköffnungssystem „TIP-ON“. Schrankelemente mit Griff sind nicht möglich.

## Waschtischplatte (1)

Rechteckige Waschtischplatte für Aufsatz-, Einbau- von oben, Unterbau-oder flächenbündiges formgepresstes Waschbecken.

STÄRKE: 12 - 15 - 20 - 23 mm.

TIEFE: 500 mm

## Schrank (2)

Aus Paneelen aus Spanplatte, Stärke 19 mm, wasserabweisend, mit geringem Formaldehydgehalt (zertifiziert Klasse E1, CARB P2 / TSCA Title VI), mit Melaminharzbeschichtung mit hoher Dichte. Vordere und rückseitige Kante aus ABS in Ausführung.

SEITENTEIL HÖHE: 300 - 470 mm ( beide sind kompatibel mit Einbaubecken von oben / Unterbaubecken / flächenbündigen formgepressten Waschbecken Boffi).

SEITENTEIL TIEFE: 470 mm.

TIEFE MIT FRONTPANEEL: 495 mm.

ELEMENTENBREITE: 300 - 450 - 600 - 900 - 1200 mm.

## Seitenteil in Ausführung (3)

An jeder Komposition werden ohne Aufpreis die externen Abschluss-Seitenteile in Ausführung gefertigt (bei Elementen mit Frontpaneelen in Corian® ist das Seitenteil in Ausführung in Ecolak weiß, bei Elementen mit Frontpaneelen in Holz 3D ist das Seitenteil glatt furniert, ohne Leisteneffekt).

Das Seitenteil in Ausführung umfasst auch die Ausführung der sichtbaren vertikalen Vorderkante (außer Lasermat).

Das Seitenteil in Ausführung ist NICHT erhältlich in MASSIVHOLZ (auch Versionen 3D / FREEHAND / SHADES). Bei diesen Ausführungen sind die Abschlusspaneele getrennt zu bestellen.

## Schubladen (4)

System LEGRABOX mit seitlichen und rückseitigen Blenden aus mattschwarz lackiertem Metall. Boden schwarze Melaminbeschichtung. Frontpaneel der Innenschubladen in melaminbeschichteter Ausführung wie Schrankelement.

## Türen und Frontpaneele (5)

In Ausführung, Stärke 23 mm, mit automatischem Drucköffnungssystem „Tip-on“.

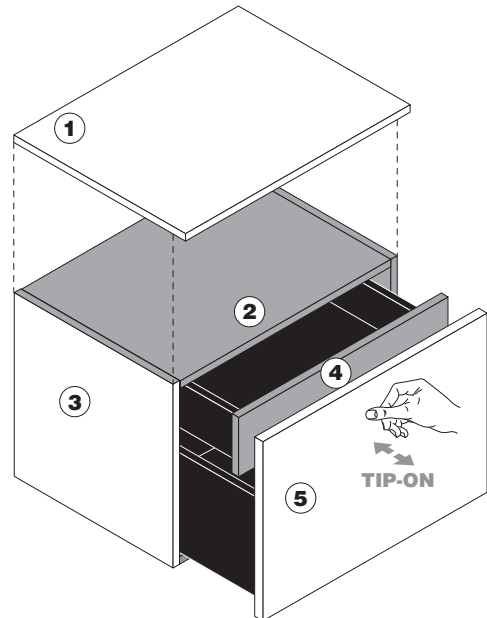



# Programma SIMPLE

ERHÄLTICHE AUSFÜHRUNGEN - ELEMENTE

MELAMINBESCHICHTETES  
SCHRANKELEMENT



606  
Ulme (Effekt  
offenporig)

610  
Thermoholz  
Lärche (Effekt  
offenporig)

608  
Eiche  
grafitgrau  
(Effekt  
offenporig)

AUSFÜHRUNG  
FRONTEN

FARBEN / HOLZARTEN

## EASYLAK+



506 Weiß Cortina  
507 Grau Leeds

## LASERMAT

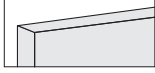

183 Weiß Kos  
178 Weiß Kos  
179 Beige Luxor  
187 Beige Arizona  
184 Grau Efeso  
202 Grau Antrim  
181 Grau Londra  
185 Grau Bromo  
203 Blue Fes  
188 Grün Comodoro



186 Kakao Orinoco  
182 Schwarz Ingo  
189 Rot Jaipur

## SILCOLAK

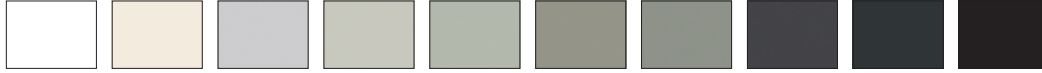
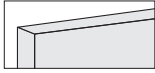

521 Weiß Sibirien  
523 Perlweiß  
524 Grau Luton  
525 Grau Schotter  
526 Heu  
527 Naturfarben  
528 Schlamm  
529 Ardoise  
530 Völlig schwarz  
531 Tiefschwarz

## ECOLAK

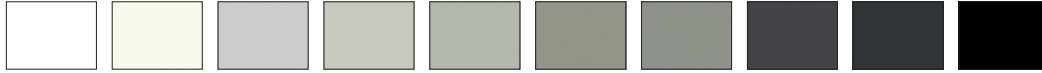
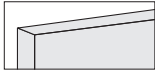

510 Arktischweiß  
129 Magnolie  
513 Wolkenfarben  
024 Kieselgrau  
512 Haferfarben  
025 Ekrü  
023 Lehm Braun  
515 Basaltgrau  
517 Kohlschwarz  
027 Schwarz

## HOLZ

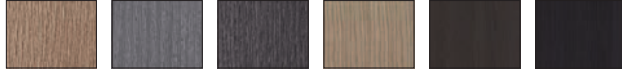

049 Eiche  
033 Eiche Aschgrau  
076 Eiche Grafitgrau  
334 Ecowood Xilo 2.0 Planked Sand (18.22)  
335 Ecowood Xilo 2.0 Planked Grey (18.23)  
333 Ecowood Xilo 2.0 Striped Black (18.04)

## POLYESTER

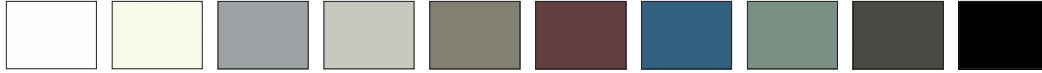
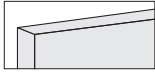

003 Weiß  
129 Magnolie  
005 Grau RAL 7038  
024 Kieselgrau  
063 Sandfarben  
107 Rot Petra  
117 Blue Jodhpur  
113 Grün caligo  
004 Grau  
027 Schwarz

## HOLZ SELECTION

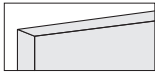

337 Amerikanische Ulme  
048 Kern-Nussbaum  
093 Nussbaum Canaletto U.S.  
101 Rächereiche

## METALS

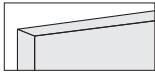

198 Weiß  
934 Aluminium  
197 Zink+  
195 Messing Vintage  
196 Kupfer+  
192 Titan  
191 Blei

## CORIAN®

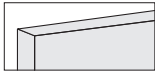

173 Weiß

# Programma SIMPLE

ERHÄLTICHE AUSFÜHRUNGEN - ELEMENTE

MELAMINBESCHICHTETES  
SCHRANKELEMENT



606  
Ulme (Effekt  
offenporig)



610  
Thermoholz  
Lärche (Effekt  
offenporig)



608  
Eiche  
grafitgrau  
(Effekt  
offenporig)

AUSFÜHRUNG  
FRONTEN

FARBEN / HOLZARTEN

## HOLZ 3D

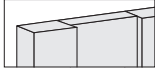

049  
Eiche



033  
Eiche  
Aschgrau



076  
Eiche  
Grafitgrau



337  
Amerikanische  
Ulme



048  
Kern-  
Nussbaum



334  
Ecowood Xilo  
2.0 Planked  
Sand (18.22)



335  
Ecowood Xilo  
2.0 Planked  
Grey (18.23)



333  
Ecowood Xilo  
2.0 Striped  
Black (18.04)



093  
Nussbaum  
Canaletto  
U.S.



101  
Räuchereiche

## MASSIVHOLZ

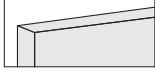

058  
Nussbaum LIGHT Canaletto  
Sägeschnitt



057  
„Antikes“  
Tannenholz  
grau



066  
Amerikanische  
Ulme SW



067  
Thermo-  
Olivesche SW



102  
Räuchereiche  
gebeizt SW

## MASSIVHOLZ 3D

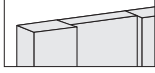

058  
Nussbaum LIGHT Canaletto  
Sägeschnitt



057  
„Antikes“  
Tannenholz  
grau



066  
Amerikanische  
Ulme SW



067  
Thermo-  
Olivesche SW



102  
Räuchereiche  
gebeizt SW

## MASSIVHOLZ FREEHAND

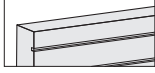

061  
Nussbaum  
LIGHT  
Canaletto



066  
Amerikanische  
Ulme SW



067  
Thermo-  
Olivesche SW



102  
Räuchereiche  
gebeizt SW

## MASSIVHOLZ SHADES

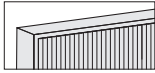

061  
Nussbaum  
LIGHT  
Canaletto



066  
Amerikanische  
Ulme SW



067  
Thermo-  
Olivesche SW



102  
Räuchereiche  
gebeizt SW

## HOLZ EXCLUSIVE



077  
Abonos fossil  
oak

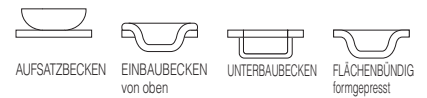

AUSFÜHRUNG  
WASCHTISCHPLATTEN FARBEN / HOLZARTEN

WASCHBECKEN

GLAS SANDBESTRAHLTES EXTRALIGHT LACKIERT - H 12 mm

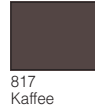
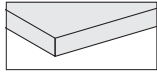

GLAS GEÄTZT EXTRALIGHT LACKIERT - H 12 mm

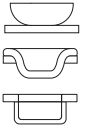
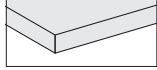

CRISTALPLANT® - H 15 mm

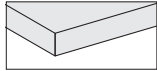

LASERMAT - H 20 mm

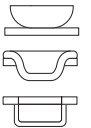
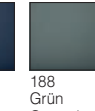
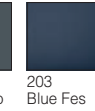
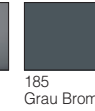
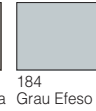
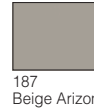
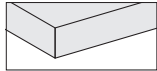

CORIAN® - H 20 mm

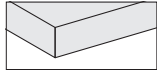

STEIN - MARMOR - GRANIT - H 20 mm

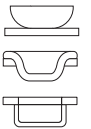
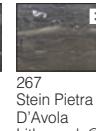
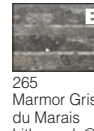
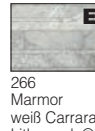
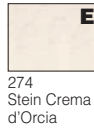
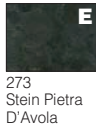
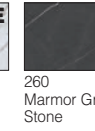
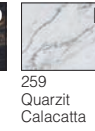
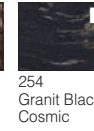
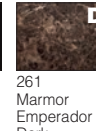
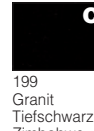
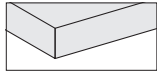

AGGLOMERAT DEKTON® - H 20 mm

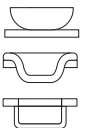
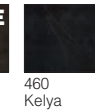
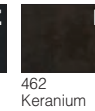
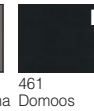
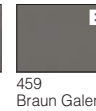
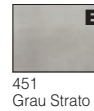
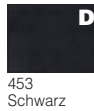
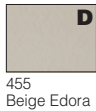
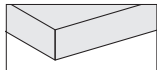

AGGLOMERAT MDI - H 12 mm

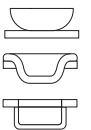
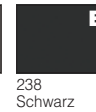
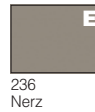
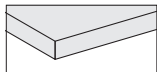

# Programma SIMPLE

ERHÄLTICHE AUSFÜHRUNGEN - WASCHTISCHPLATTEN

WASCHBECKENARTEN



AUFSATZBECKEN



EINBAUBECKEN  
von oben



UNTERBAUBECKEN



FLÄCHENBÜNDIG  
formgepresst

AUSFÜHRUNG

WASCHTISCHPLATTEN FARBEN / HOLZARTEN

WASCHBECKEN

MASSIVHOLZ - H 23 mm

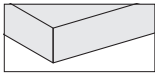

058  
Nussbaum LIGHT Caradello  
Sageschnitt



057  
„Antikes“  
Tannenholz  
grau



066  
Amerikanische  
Ulme SW



067  
Thermo-  
Olivesche SW



102  
Räuchereiche  
gebeizt SW



# Programma SIMPLE

Design Piero Lissoni + C.R.S. Boffi

Sistema modular de muebles contenedores bajos / columna suspendidos equipados de sistema de apertura automática a presión "tip-on". No es posible realizar muebles contenedores equipados con tirador.

## Encimera (1)

Encimera en ángulo recto que se puede equipar con lavabos sobre encimera apoyados, sobre encimera empotrados, bajo encimera empotrados y enrasados a la encimera moldeados.

GROSOR: 12 - 15 - 20 - 23 mm.

PROFUNDIDAD: 500 mm.

## Contenedor (2)

Realizados en paneles de partículas de madera grosor 19 mm, hidrófugos, con bajo contenido de formaldehído (certificado clase E1, CARB P2/ TSCA Title VI) melamínico con papeles con alto gramaje tratados con resinas melamínicas. Borde delantero y trasero en ABS del mismo color.

ALTURA COSTADO: 300 - 470 mm (ambas compatibles con lavabos Boffi sobre encimera empotrados / bajo encimera empotrados / enrasados a la encimera moldeados).

PROFUNDIDAD COSTADO: 470 mm.

PROFUNDIDAD CON FRENTE: 495 mm.

ANCHURA MÓDULO: 300 - 450 - 600 - 900 - 1200 mm.

## Lateral en acabado (3)

En cada composición se realizan, sin incremento de precio, los costados externos terminales en acabado (hay que considerar que para los muebles con frentes de Corian® el costado acabado será de Ecolak blanco / para muebles con frentes Madera 3D el costado acabado será chapado liso, sin efecto-alistonado).

El costado en acabado también incluye el acabado del borde vertical a la vista (excepto Lasermat).

El costado en acabado NO es realizable en MADERA MACIZA (incluso en las versiones 3D / FREEHAND / SHADES). Para estos acabados es necesario pedir los paneles terminales por separado.

## Cajones (4)

Sistema LEGRABOX, con laterales y trasera de metal pintado en color negro mate. Fondo de madera ennoblecida negra. Frente cajones internos en madera ennoblecida acabado mueble contenedor.

## Puertas y frentes (5)

Realizadas en acabado, grosor 23 mm, con apertura automática "tip-on".

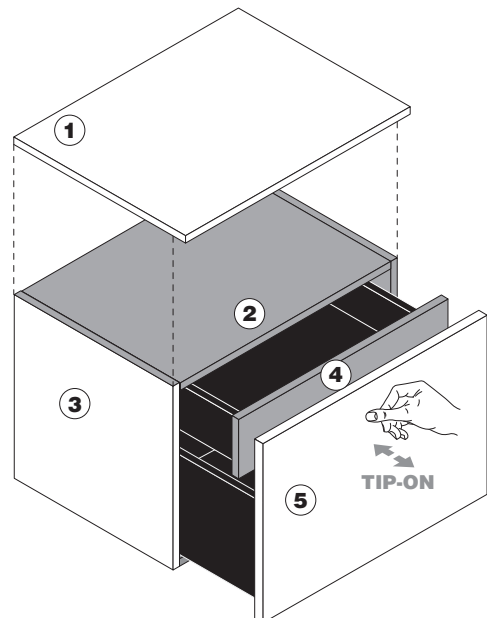

# Programma SIMPLE

ACABADOS REALIZABLES - MUEBLES

MUEBLE  
CONTENEDOR  
ENNOBLECIDO.



606  
Olmo (efecto  
poro abierto)



610  
Alerce  
térmico  
(efecto poro  
abierto)



608  
Roble grafito  
(efecto poro  
abierto)

ACABADO  
FRENTES

COLORES / MADERAS

## EASYLAK+

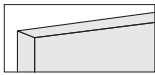

506  
Blanco  
Cortina



507  
Gris Leeds

## LASERMAT

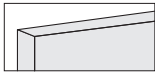

183  
Blanco Kos



178  
Blanco Malè



179  
Beige Luxor



187  
Beige Arizona



184  
Gris Efeso



202  
Gris Antrim



181  
Gris Londra



185  
Gris Bromo



203  
Azul Fes



188  
Verde  
Comodoro



186  
Cacao  
Orinoco



182  
Negro Ingo



189  
Rojo Jaipur

## SILCOLAK

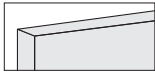

521  
Blanco  
Siberia



523  
Ostra



524  
Gris Luton



525  
Grava



526  
Heno



527  
Cuerda



528  
Limo



529  
Pizarra



530  
Negro Abismo



531  
Negro Intenso

## ECOLAK

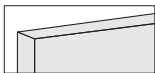

510  
Blanco ártico



129  
Magnolia



513  
Nube



024  
Guijarro



512  
Avena



025  
Crudo



023  
Fango



515  
Basalto



517  
Carbón



027  
Negro

## MADERA



049  
Roble



033  
Roble ceniza



076  
Roble grafito



334  
Ecowood Xilo  
2.0 Planked  
Sand (18.22)



335  
Ecowood Xilo  
2.0 Planked  
Grey (18.23)



333  
Ecowood Xilo  
2.0 Striped  
Black (18.04)

## POLIÉSTER



003  
Blanco



129  
Magnolia



005  
Gris RAL  
7038



024  
Guijarro



063  
Arena



107  
Rojo Petra



117  
Azul Jodhpur



113  
Verde caligo



004  
Gris



027  
Negro

## MADERA SELECTION

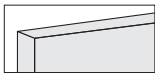

337  
Olmo  
americano



048  
Alma de  
nogal



093  
Nogal canaletto  
(americano)  
U.S.



101  
Roble  
ahumado

## METALS



198  
Blanco



934  
Aluminium



197  
Zink+



195  
Latón Vintage



196  
Cobre+



192  
Titanio



191  
Plomo

## CORIAN®



173  
Blanco

# Programma SIMPLE

ACABADOS REALIZABLES - MUEBLES

MUEBLE  
CONTENEDOR  
ENNOBLECIDO.



606  
Olmo (efecto  
poro abierto)

610  
Alerce  
térnico  
(efecto poro  
abierto)

608  
Roble grafito  
(efecto poro  
abierto)

ACABADO  
FRENTEROS

COLORES / MADERAS

## MADERA 3D

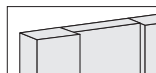

049  
Roble

033  
Roble ceniza

076  
Roble grafito

337  
Olmo  
americano

048  
Alma de  
nogal

334  
Ecowood Xilo  
2.0 Planked  
Sand (18.22)

335  
Ecowood Xilo  
2.0 Planked  
Grey (18.23)

333  
Ecowood Xilo  
2.0 Striped  
Black (18.04)

093  
Nogal canaletto  
(americano)  
U.S.

101  
Roble  
ahumado

## MADERA MACIZA

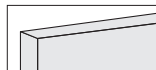

058  
Nogal LIGHT  
canaletto  
"corte sierra"

057  
Abeto  
"antiguo" gris

066  
Olmo  
americano  
SW

067  
Fresno Olivato  
termotratado SW

102  
Roble teñido  
ahumado SW

## MADERA MACIZA 3D

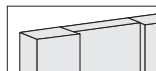

058  
Nogal LIGHT  
canaletto  
"corte sierra"

057  
Abeto  
"antiguo" gris

066  
Olmo  
americano  
SW

067  
Fresno Olivato  
termotratado SW

102  
Roble teñido  
ahumado SW

## MADERA MACIZA FREEHAND

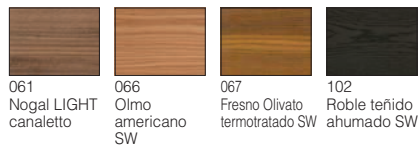
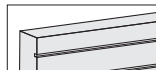

061  
Nogal LIGHT  
canaletto

066  
Olmo  
americano  
SW

067  
Fresno Olivato  
termotratado SW

102  
Roble teñido  
ahumado SW

## MADERA MACIZA SHADES

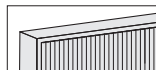

061  
Nogal LIGHT  
canaletto

066  
Olmo  
americano  
SW

067  
Fresno Olivato  
termotratado SW

102  
Roble teñido  
ahumado SW

## MADERA EXCLUSIVE



077  
Abonos fossil  
oak

# Programma SIMPLE

ACABADOS REALIZABLES - ENCIMERAS

TIPOS LAVABOS



SOBRE  
ENCIMERA  
apoyado



SOBRE  
ENCIMERA  
empotrado



BAJO  
ENCIMERA  
empotrado



ENRASADO  
A LA  
ENCIMERA  
moldeado

ACABADO  
ENCIMERAS

COLORES / MADERAS

LAVABOS

VIDRIO EXTRALIGHT ARENADO LACADO - H 12 mm

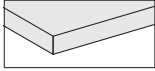

818  
Blanco



816  
Tortola



817  
Café



VIDRIO EXTRALIGHT ACIDADO LACADO - H 12 mm

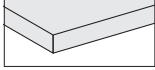

818  
Blanco



816  
Tortola

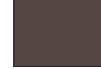

817  
Café



CRISTALPLANT® - H 15 mm

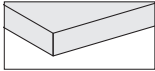

-  
Blanco



LASERMAT - H 20 mm

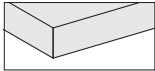

183  
Blanco Kos



178  
Blanco Malè

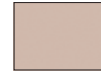

179  
Beige Luxor



187  
Beige Arizona



184  
Gris Efeso

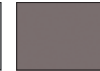

181  
Gris Londra

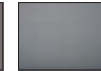

202  
Gris Antrim



185  
Gris Bromo

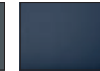

203  
Azul Fes

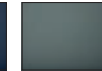

188  
Verde  
Comodoro



186  
Cacao  
Orinoco



182  
Negro Ingo

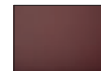

189  
Rojo Jaipur



CORIAN® - H 20 mm

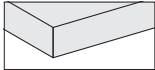

173  
Blanco



PIEDRA - MÁRMOL - GRANITO - H 20 mm

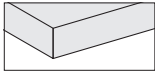

240  
Mármol  
blanco  
Carrara



250  
Piedra  
Serena



257  
Cuarcita  
Silver

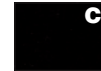

199  
Granito Negro  
Absolute  
Zimbabwe

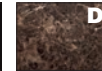

261  
Mármol  
Emperador  
Dark

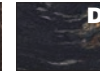

254  
Granito Black  
Cosmic



259  
Cuarcita  
Calacatta



260  
Mármol Grey  
Stone



273  
Pietra d'Avola



274  
Piedra Crema  
d'Orcia



266  
Mármol blanco  
Carrara  
Lithoverde®



265  
Mármol Gris  
du Marais  
Lithoverde®



267  
Pietra d'Avola  
Lithoverde®



COMPUESTO DEKTON® - H 20 mm

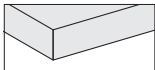

455  
Beige Edora



453  
Negro Sirius



454  
Blanco Zenith

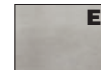

451  
Gris Strato



459  
Marrón  
Galema



461  
Domoos

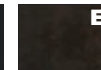

462  
Keranium



460  
Kelya



COMPUESTO MDI - H 12 mm

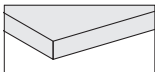

233  
Blanco



234  
Camello



236  
Visón



237  
Gris



238  
Negro



231  
Devon



232  
Surrey





# Programma SIMPLE

ACABADOS REALIZABLES - ENCIMERAS

TIPOS LAVABOS



SOBRE  
ENCIMERA  
apoyado



SOBRE  
ENCIMERA  
empotrado



BAJO  
ENCIMERA  
empotrado



ENRASADO  
A LA  
ENCIMERA  
moldeado

ACABADO  
ENCIMERAS

COLORES / MADERAS

LAVABOS

MADERA MACIZA - H 23 mm

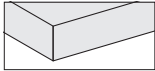

058  
Nogal LIGHT  
canaletto  
"corte sierra"



057  
Abeto  
"antiguo" gris



066  
Olmo  
americano  
SW



067  
Fresno Olivato  
termotratado SW



102  
Roble teñido  
ahumado SW

