

R.I.G. BATHROOM

Rudimentary Interior Geometry
Design Mikal Harrsen

Sistema bagno componibile.

Il modulo è stato appositamente studiato per l'utilizzo nelle stanze da bagno, in modo da ottenere composizioni sia a parete che ad isola.

Per eventuali installazioni ad isola, seguire scrupolosamente le regole evidenziate nella sezione 'note per la progettazione' e nelle indicazioni specifiche di ogni componente.

Strutture (1), stabilizzatori (2), supporti (3), aste

Acciaio inox AISI 304 pieno (salvo diversa segnalazione nella pagine specifiche dei singoli prodotti), verniciato a polvere (nero gofrato) oppure verniciato a liquido (ottone).

Piedini regolabili in acciaio inox.

COLORI: nero gofrato, ottone.

Ripiani (4)

EASYLAK+ / SILCOLAK: realizzato in pannello in agglomerato ligneo MDF medium density, a basso contenuto di formaldeide (certificato classe E1, CARB P2 / TSCA Title VI). Ripiano caratterizzato da smussi inclinati a vista sul lato frontale e sul lato posteriore. Spessore 22 mm, laccato.

LASERMAT + CDF NERO / LEGNO + CDF NERO / LEGNO SELECTION + CDF NERO: realizzato in pannello ecologico in fibra di legno ad alta densità (CDF - certificato classe E1, CARB P2 / TSCA Title VI). Ripiano caratterizzato da smussi inclinati a vista sul lato frontale e sul lato posteriore. Spessore 12/19 mm, bordo nero a vista.

VETRO: spessore 6 mm, temperato con bordo filo lucido.

CORIAN® / MARMO / PIETRA / COMPOSITO MDI: ripiano squadrato spessore 12 mm.

Capacità massima di carico (le portate indicate si riferiscono a sezioni L 27,5 / L 55 / L 110 cm, con pesi distribuiti uniformemente):

- spessore 0,6 cm: max 20 kg
- spessore 1,2 cm: max 30 kg
- spessore 1,9 - 2,2 cm: max 50 kg

Top (5)

EASYLAK+ / SILCOLAK: realizzato in pannello in agglomerato ligneo MDF medium density, a basso contenuto di formaldeide (certificato classe E1, CARB P2 / TSCA Title VI). Ripiano caratterizzato da smussi inclinati a vista sul lato frontale e sul lato posteriore. Spessore 22 mm, laccato.

LASERMAT + CDF NERO / LEGNO + CDF NERO / LEGNO SELECTION + CDF NERO: realizzato in pannello ecologico in fibra di legno ad alta densità (CDF - certificato classe E1, CARB P2 / TSCA Title VI). Spessore 12 mm, bordo nero a vista.

CORIAN® / MARMO / PIETRA / COMPOSITO MDI: piano squadrato spessore 12 mm.

Capacità massima di carico: vedi 'Ripiani'.

Contenitore (6)

Realizzato in pannelli di particelle di legno spessore 19 mm, a basso contenuto di formaldeide (certificato classe E1, CARB P2 / TSCA Title VI), nobilitato con carte ad alta grammatura trattate con resine melamminiche. Bordo anteriore e posteriore in ABS in tinta.

Cassetti (7)

Sistema LEGRABOX, con spondine laterali e posteriore in metallo verniciato in colore nero opaco. Fondo in nobilitato nero e frontale (cassetti interni) in nobilitato finitura contenitore.

Frontali (8), pannelli posteriori (9), fianchi laterali (10)

EASYLAK+ / SILCOLAK: realizzato in pannello in agglomerato ligneo MDF medium density, a basso contenuto di formaldeide (certificato classe E1, CARB P2 / TSCA Title VI). Laccato.

LASERMAT + CDF NERO / LEGNO + CDF NERO / LEGNO SELECTION + CDF NERO: realizzato in pannello ecologico in fibra di legno ad alta densità (CDF - certificato classe E1, CARB P2 / TSCA Title VI). Bordo nero a vista.

MARMO / PIETRA / COMPOSITO MDI: pannello squadrato spessore 12 mm (fianchi laterali spessori 10 mm).

Frontali con apertura automatica a pressione "TIP-ON".

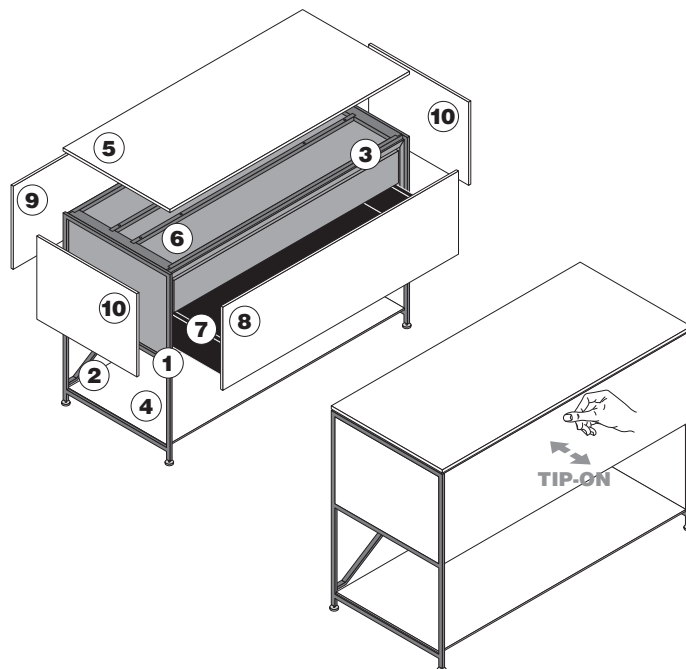

* Finitura esclusiva R.I.G. BATHROOM

FINITURA
FRONTALI

COLORI / ESSENZE

EASYLAK+

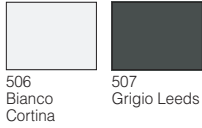

506 Bianco Cortina
507 Grigio Leeds

LASERMAT + CDF NERO - Bordo nero a vista.

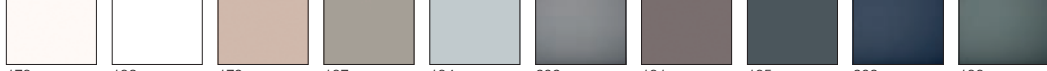

178 Bianco Malè
183 Bianco Kos
179 Beige Luxor
187 Beige Arizona
184 Grigio Efeso
202 Grigio Antrim
181 Grigio Londra
185 Grigio Bromo
203 Blu Fes
188 Verde Comodoro



186 Cacao Orinoco
182 Nero Ingo
189 Rosso Jaipur

SILCOLAK

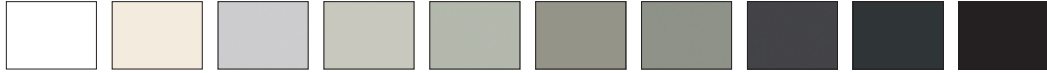
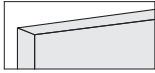

521 Bianco Siberia
523 Ostrica
524 Grigio Luton
525 Ghiaia
526 Fieno
527 Corda
528 Limo
529 Ardesia
530 Abisso
531 Nero Intenso

LEGNO + CDF NERO - Bordo nero a vista.

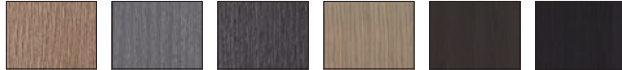

049 Rovere
033 Rovere cenere
076 Rovere grafite
334 Ecowood Xilo 2.0 Planked Sand (18.22)
335 Ecowood Xilo 2.0 Planked Grey (18.23)
333 Ecowood Xilo 2.0 Striped Black (18.04)

LEGNO SELECTION + CDF NERO - Bordo nero a vista.

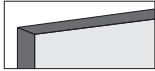

337 Olmo americano
048 Noce colore
093 Noce canaletto U.S.
101 Rovere affumicato

PIETRA - MARMO

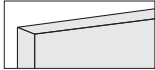

240 Marmo bianco Carrara
260 Marmo Grey Stone
273 Pietra d'Avola

COMPOSITO MDI



233 Bianco
234 Cammello
236 Visone
237 Grigio
238 Nero
231 Devon
232 Surrey

R.I.G. BATHROOM

FINITURE REALIZZABILI - RIPIANI

* Finitura esclusiva R.I.G. BATHROOM

FINITURA RIPIANI COLORI / ESSENZE

EASYLAK+ - H 22 mm

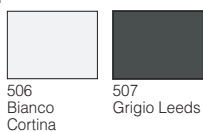
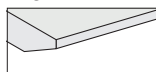

506
Bianco
Cortina

507
Grigio Leeds

LASERMAT + CDF NERO - H 12 / 19 mm - Bordo nero a vista.

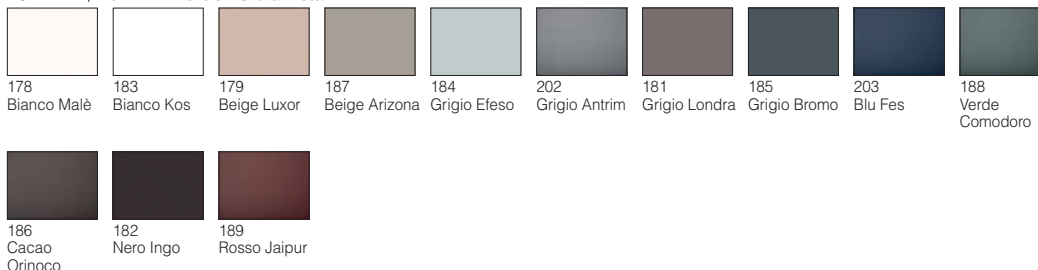
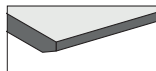

178
Bianco Malè

183
Bianco Kos

179
Beige Luxor

187
Beige Arizona

184
Grigio Efeso

202
Grigio Antrim

181
Grigio Londra

185
Grigio Bromo

203
Blu Fes

188
Verde
Comodoro

186
Cacao
Orinoco

182
Nero Ingo

189
Rosso Jaipur

VETRO - H 6 mm

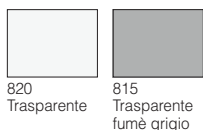
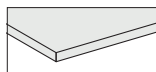

820
Trasparente

815
Trasparente
fumè grigio

SILCOLAK - H 22 mm

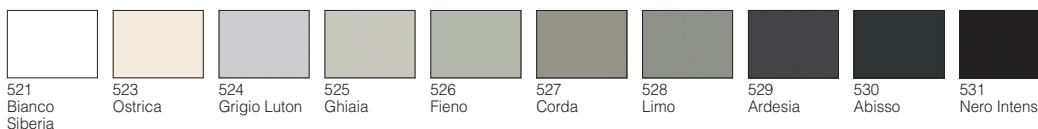
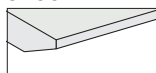

521
Bianco
Siberia

523
Ostrica

524
Grigio Luton

525
Ghiaia

526
Fieno

527
Corda

528
Limo

529
Ardesia

530
Abisso

531
Nero Intenso

LEGNO + CDF NERO - H 12 / 19 mm - Bordo nero a vista.

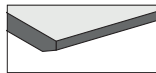

049
Rovere

033
Rovere
cenere

076
Rovere grafite

334
Ecowood Xilo
2.0 Planked
Sand (18.22)

335
Ecowood Xilo
2.0 Planked
Grey (18.23)

333
Ecowood Xilo
2.0 Striped
Black (18.04)

LEGNO SELECTION + CDF NERO - H 12 / 19 mm - Bordo nero a vista.

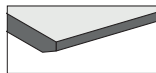

337
Olmo
americano

048
Noce colore

093
Noce
canaletto U.S.

101
Rovere
affumicato

CORIAN® - H 12 mm

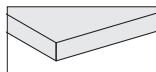

173
Bianco

CORIAN® EXTRA - H 12 mm

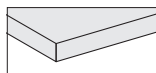

171
Grigio Stratus
semi-lucido

PIETRA - MARMO - H 12 mm

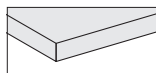

240
Marmo bianco
Carrara

260
Marmo Grey
Stone

273
Pietra d'Avola

955
Pietra
lavica nera
enneDue *

R.I.G. BATHROOM

FINITURE REALIZZABILI - RIPIANI

* Finitura esclusiva R.I.G. BATHROOM

FINITURA RIPIANI COLORI / ESSENZE

COMPOSITO MDI - H 12 mm

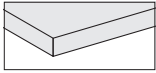

233
Bianco



234
Cammello



236
Visone



237
Grigio



238
Nero



231
Devon



232
Surrey



* Finitura esclusiva R.I.G. BATHROOM

FINITURA PIANI COLORI / ESSENZE

EASYLAK+

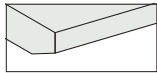

506
Bianco
Cortina



507
Grigio Leeds



LASERMAT + CDF NERO - H 12 mm - Bordo nero a vista.

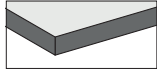

178
Bianco Malè



183
Bianco Kos



179
Beige Luxor



187
Beige Arizona



184
Grigio Efeso



202
Grigio Antrim



181
Grigio Londra



185
Grigio Bromo



203
Blu Fes



188
Verde
Comodoro



186
Cacao
Orinoco



182
Nero Ingo



189
Rosso Jaipur



SILCOLAK

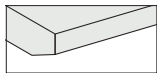

521
Bianco
Siberia



523
Ostrica



524
Grigio Luton



525
Ghiaia



526
Fieno



527
Corda



528
Limo



529
Ardesia



530
Abisso



531
Nero Intenso



LEGNO + CDF NERO - H 12 mm - Bordo nero a vista.

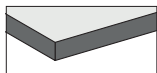

049
Rovere



033
Rovere
cenere



076
Rovere grafite



334
Ecowood Xilo
2.0 Planked
Sand (18.22)



335
Ecowood Xilo
2.0 Planked
Grey (18.23)



333
Ecowood Xilo
2.0 Striped
Black (18.04)



LEGNO SELECTION + CDF NERO - H 12 mm - Bordo nero a vista.

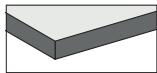

337
Olmo
americano



048
Noce colore



093
Noce
canaletto U.S.



101
Rovere
affumicato



CORIAN® - H 12 mm

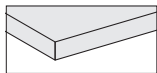

173
Bianco



CORIAN® EXTRA - H 12 mm

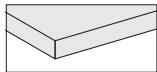

171
Grigio Stratus
semi-lucido



PIETRA - MARMO - H 12 mm

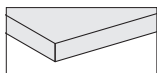

240
Marmo bianco
Carrara



260
Marmo Grey
Stone



273
Pietra d'Avola



955
Pietra
lavica nera
enneDue *



COMPOSITO MDI - H 12 mm

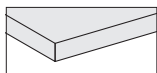

233
Bianco



234
Cammello



236
Visone



237
Grigio



238
Nero



231
Devon



232
Surrey



R.I.G. BATHROOM

Rudimentary Interior Geometry
Design Mikal Harrsen

Modular bathroom system.

The module has been specifically designed for use in bathrooms, in order to propose both wall and island compositions.

In case of island installation, please follow strictly the rules of the section 'notes to designer' and the specific indications for each component.

Uprights (1), stabilizers (2), supports (3), rods

AINSI 304 solid stainless steel (unless differently indicated in the specific pages of the individual products), powder-coated (embossed black) or liquid painted (brass).
Stainless steel adjustable feet.

COLOURS: embossed black, brass.

Shelves (4)

EASYLAK+ / SILCOLAK: MDF medium density fibres board, with low formaldehyde emission (class E1, CARB P2 / TSCA Title VI certified). Shelf has visible front and rear bevelled edges. 22 mm thick, lacquered.

LASERMAT + BLACK CDF / WOOD + BLACK CDF / WOOD SELECTION + BLACK CDF: made of eco-friendly panel in high density wood fibre (CDF - class E1, CARB P2 / TSCA Title VI certified). Shelf has visible bevelled front and rear edges. Visible black edge, 12/19 mm thick.

GLASS: tempered, 6 mm. thick, with polished edge.

CORIAN® / MARBLE / STONE / MDI COMPOSITE: 12 mm. thick square-edged shelf.

Max. load capacity (the indicated capacities are referred to W 27,5 / W 55 / W 110 cm. modules, with equally distributed weights):

- 0,6 cm th.: max 20 kg
- 1,2 cm th.: max 30 kg
- 1,9 - 2,2 cm th.: max 50 kg

Top (5)

EASYLAK+ / SILCOLAK: MDF medium density fibres board, with low formaldehyde emission (class E1, CARB P2 / TSCA Title VI certified). Shelf has visible front and rear bevelled edges. 22 mm thick, lacquered.

LASERMAT + BLACK CDF / WOOD + BLACK CDF / WOOD SELECTION + BLACK CDF: made of eco-friendly panel in high density wood fibre (CDF - class E1, CARB P2 / TSCA Title VI certified). Visible black edge, 12 mm thick.

CORIAN® / MARBLE / STONE / MDI COMPOSITE: 12 mm. thick square-edged top.
Max. load capacity: see "Shelves".

Unit (6)

It's made of 19 mm thick wood particle board panels, with low formaldehyde emission (class E1, CARB P2 / TSCA Title VI certified), treated with high performance melamine resin. Front and back edges in ABS, same colour

Drawers (7)

LEGRABOX series with sides and back in varnished matt black metal. Bottom in black melamine and front (of internal drawers) in melamine, same finish as carcass.

Front panels (8), rear panels (9), side panels (10)

EASYLAK+ / SILCOLAK: MDF medium density fibres board, with low formaldehyde emission (class E1, CARB P2 / TSCA Title VI certified). Lacquered.

LASERMAT + BLACK CDF / WOOD + BLACK CDF / WOOD SELECTION + BLACK CDF: made of eco-friendly panel in high density wood fibre (CDF - class E1, CARB P2 / TSCA Title VI certified). Visible black edge.

MARBLE / STONE / MDI COMPOSITE: 12 mm. thick square-edged panel (10 mm. thick side panels).

Front panels with automatic "TIP-ON" push opening.

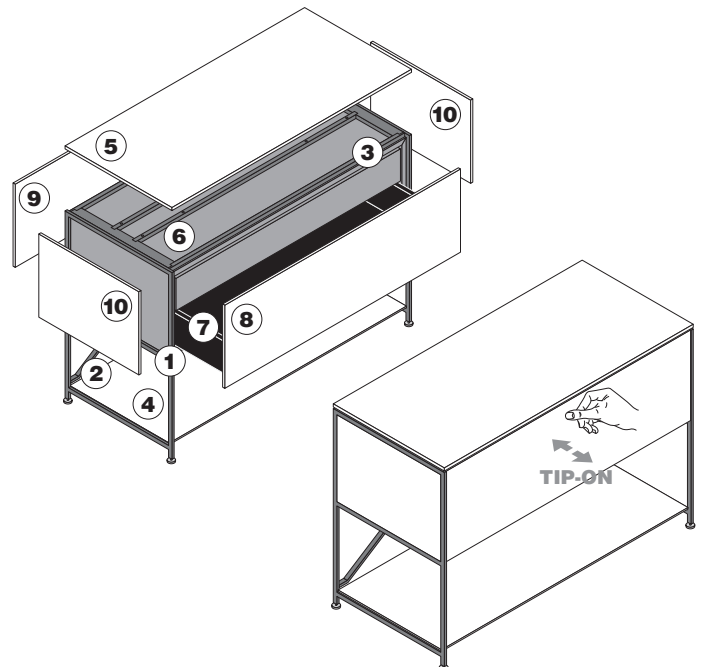



* Exclusive finishing R.I.G. BATHROOM

FRONT PANELS
FINISH COLOURS / SPECIES

EASYLAK+

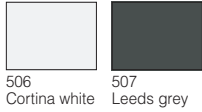

506 Cortina white
507 Leeds grey

LASERMAT + BLACK CDF - Visible black edge.

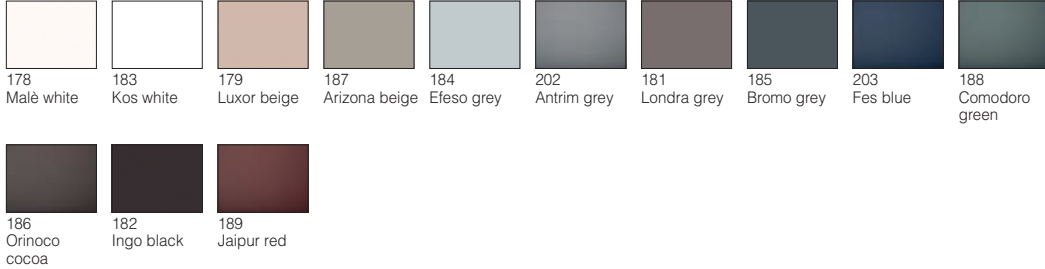
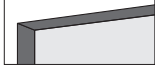

178 Malè white
183 Kos white
179 Luxor beige
187 Arizona beige
184 Efeso grey
202 Antrim grey
181 Londra grey
185 Bromo grey
203 Fes blue
188 Comodoro green

186 Orinoco cocoa
182 Ingo black
189 Jaipur red

SILCOLAK

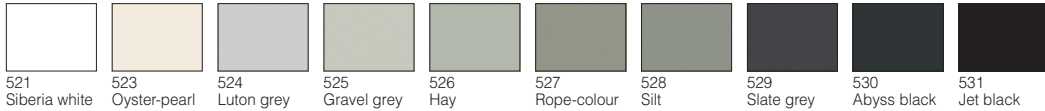
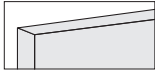

521 Siberia white
523 Oyster-pearl
524 Luton grey
525 Gravel grey
526 Hay
527 Rope-colour
528 Silt
529 Slate grey
530 Abyss black
531 Jet black

WOOD + BLACK CDF - Visible black edge.

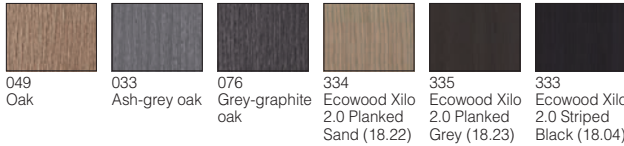

049 Oak
033 Ash-grey oak
076 Grey-graphite oak
334 Ecowood Xilo 2.0 Planked Sand (18.22)
335 Ecowood Xilo 2.0 Planked Grey (18.23)
333 Ecowood Xilo 2.0 Striped Black (18.04)

WOOD SELECTION + BLACK CDF - Visible black edge.

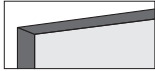

337 American elm
048 Core walnut
093 Canaletto walnut U.S.
101 Smoked oak

STONE - MARBLE

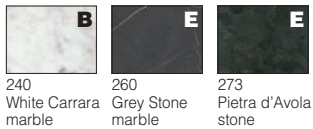

240 White Carrara marble
260 Grey Stone marble
273 Pietra d'Avola stone

MDI COMPOSITE



233 White
234 Camel
236 Mink
237 Grey
238 Black
231 Devon
232 Surrey

R.I.G. BATHROOM

FEASIBLE FINISHES - SHELVES

* Exclusive finishing R.I.G. BATHROOM

SHELVES FINISH COLOURS / SPECIES

EASYLAK+ - H 22 mm

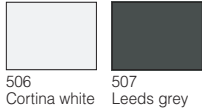
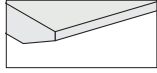

LASERMAT + BLACK CDF - H 12 / 19 mm - Visible black edge.

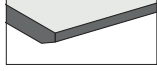

GLASS - H 6 mm

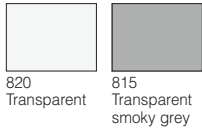
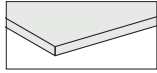

SILCOLAK - H 22 mm

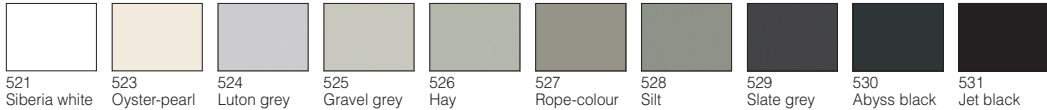
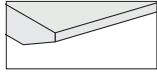

WOOD + BLACK CDF - H 12 / 19 mm - Visible black edge.

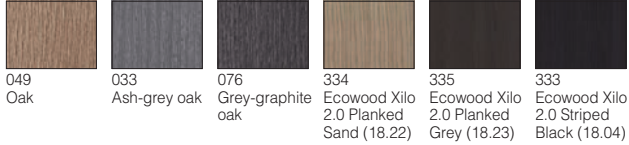
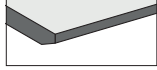

WOOD SELECTION + BLACK CDF - H 12 / 19 mm - Visible black edge.

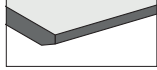

CORIAN® - H 12 mm

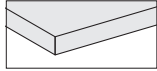

CORIAN® EXTRA - H 12 mm

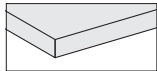

STONE - MARBLE - H 12 mm

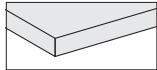

R.I.G. BATHROOM

FEASIBLE FINISHES - SHELVES

* Exclusive finishing R.I.G. BATHROOM

SHELVES FINISH COLOURS / SPECIES

MDI COMPOSITE - H 12 mm

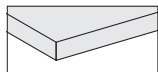

233
White



234
Camel



236
Mink



237
Grey



238
Black



231
Devon



232
Surrey

* Exclusive finishing R.I.G. BATHROOM

TOPS FINISH

COLOURS / SPECIES

EASYLAK+

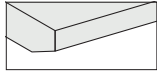

506
Cortina white



507
Leeds grey



LASERMAT + BLACK CDF - H 12 mm - Visible black edge.

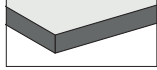

178
Malè white



183
Kos white



179
Luxor beige



187
Arizona beige



184
Efeso grey



202
Antrim grey



181
Londra grey



185
Bromo grey



203
Fes blue



188
Comodoro
green



186
Orinoco
cocoa



182
Ingo black



189
Jaipur red



SILCOLAK

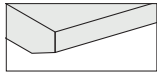

521
Siberia white



523
Oyster-pearl



524
Luton grey



525
Gravel grey



526
Hay



527
Rope-colour



528
Silt



529
Slate grey



530
Abyss black



531
Jet black



WOOD + BLACK CDF - H 12 mm - Visible black edge.

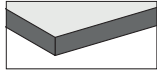

049
Oak



033
Ash-grey oak



076
Grey-graphite
oak



334
Ecowood Xilo
2.0 Planked
Sand (18.22)



335
Ecowood Xilo
2.0 Planked
Grey (18.23)



333
Ecowood Xilo
2.0 Striped
Black (18.04)



WOOD SELECTION + BLACK CDF - H 12 mm - Visible black edge.

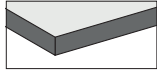

337
American elm



048
Core walnut



093
Canaletto
walnut U.S.



101
Smoked oak



CORIAN® - H 12 mm

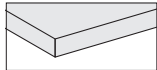

173
White



CORIAN® EXTRA - H 12 mm

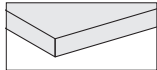

171
Semi-glossy
Stratus grey



STONE - MARBLE - H 12 mm

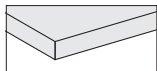

240
White Carrara
marble



260
Grey Stone
marble



273
Pietra d'Avola
stone



955
enneDue *
black lava
stone



MDI COMPOSITE - H 12 mm

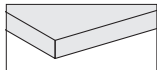

233
White



234
Camel



236
Mink



237
Grey



238
Black



231
Devon



232
Surrey



R.I.G. BATHROOM

Rudimentary Interior Geometry
Design Mikal Harrsen

Système salle de bains modulable.

Le module a été spécialement conçu pour l'utilisation dans les salles de bains, de sorte à obtenir des compositions murales et en îlot.

Pour d'éventuelles installations en îlot, suivre scrupuleusement les règles indiquées dans la section 'notes pour le projet' et dans les indications spécifiques de chaque composant.

Structures (1), stabilisateurs (2), supports (3), tiges

Acier inox AISI 304 plein (sauf indication différente dans les pages spécifiques des produits), peint à poudre (noir gaufré) ou laqué liquide (laiton).

Pieds réglables en acier inox.
COULEURS: noir gaufré, laiton.

Étagères (4)

EASYLAK+ / SILCOLAK: réalisé en panneau en aggloméré de bois MDF medium density, à basse teneur en formaldéhyde (certifié classe E1, CARB P2 / TSCA Title VI). Étagère caractérisée par des chanfreins inclinés apparents sur le côté avant et sur le côté arrière. Épaisseur 22 mm, laqué.

LASERMAT + CDF NOIR / BOIS + CDF NOIR / BOIS SELECTION + CDF NOIR: réalisé en panneau écologique en fibre de bois à haute densité (CDF - certifié classe E1, CARB P2 / TSCA Title VI). Étagère caractérisée par des chanfreins inclinés apparents sur le côté avant et sur le côté arrière. Épaisseur 12 / 19 mm, chant noir apparent.

VERRE: épaisseur 6 mm, trempé avec bords polis.

CORIAN® / MARBRE / PIERRE / COMPOSITE MDI: étagère droite épaisseur 12 mm.

Capacité maximum de chargement (les portées indiquées font référence aux sections L 27,5 / L 55 / L 110 cm, avec poids distribués uniformément):

- épaisseur 0,6 cm: max 20 kg
- épaisseur 1,2 cm: max 30 kg
- épaisseur 1,9 - 2,2 cm: max 50 kg

Top (5)

EASYLAK+ / SILCOLAK: réalisé en panneau en aggloméré de bois MDF medium density, à basse teneur en formaldéhyde (certifié classe E1, CARB P2 / TSCA Title VI). Étagère caractérisée par des chanfreins inclinés apparents sur le côté avant et sur le côté arrière. Épaisseur 22 mm, laqué.

LASERMAT + CDF NOIR / BOIS + CDF NOIR / BOIS SELECTION + CDF NOIR: réalisé en panneau écologique en fibre de bois à haute densité (CDF - certifié classe E1, CARB P2 / TSCA Title VI). Épaisseur 12 mm, chant noir apparent.

CORIAN® / MARBRE / PIERRE / COMPOSITE MDI: plan droit épaisseur 12 mm.

Capacité maximum de chargement: voir 'Étagères'.

Caisson (6)

Réalisé en panneaux de particules de bois d'épaisseur 19 mm, à faible teneur en formaldéhyde (classe E1 / TSCA Title VI) mélaminé avec papiers à haute densité traités avec des résines mélaminiques. Chant avant et arrière en ABS de la même couleur.

Tiroirs (7)

Système LEGRABOX, avec rebords latéraux et arrière en métal peint en couleur noir mat. Fond en mélaminé noir et façade (tiroirs internes) en mélaminé finition caisson.

Façades (8), panneaux arrière (9), côtés latéraux (10)

EASYLAK+ / SILCOLAK: réalisé en panneau en aggloméré de bois MDF medium density, à basse teneur en formaldéhyde (certifié classe E1, CARB P2 / TSCA Title VI). Laqué.

LASERMAT + CDF NOIR / BOIS + CDF NOIR / BOIS SELECTION + CDF NOIR: réalisé en panneau écologique en fibre de bois à haute densité (CDF - certifié classe E1, CARB P2 / TSCA Title VI). Chant noir apparent.

MARBRE / PIERRE / COMPOSITE MDI: panneau droit épaisseur 12 mm (côtés latéraux épaisseurs 10 mm).

Façades avec ouverture automatique par pression "TIP-ON".

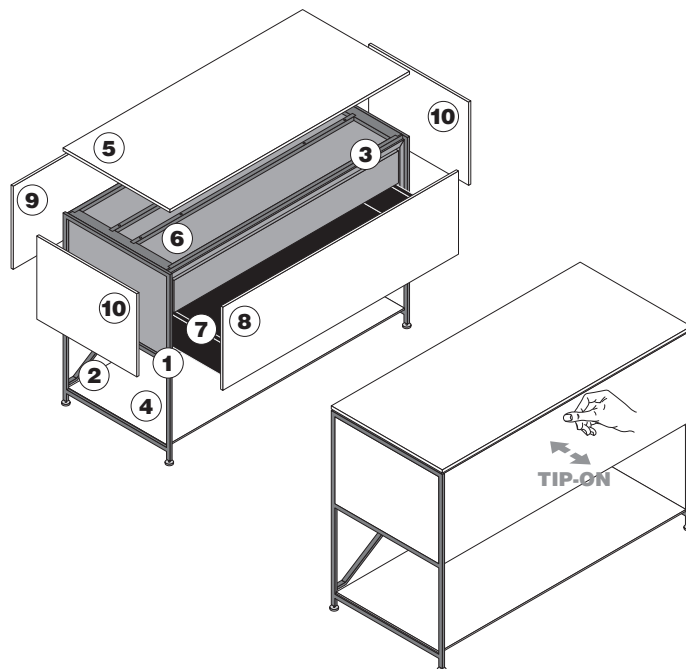



* Finition exclusive R.I.G. BATHROOM

FINITION FAÇADES COULEURS / ESSENCES

EASYLAK+

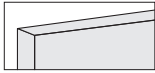

506
Blanc Cortina



507
Gris Leeds

LASERMAT + CDF NERO - Chant noir apparent.



178
Blanc Malè



183
Blanc Kos



179
Beige Luxor



187
Beige Arizona



184
Gris Efeso



202
Gris Antrim



181
Gris Londra



185
Gris Bromo



203
Bleu Fes



188
Vert
Comodoro



186
Cacao
Orinoco



182
Noir Ingo



189
Rouge Jaipur

SILCOLAK

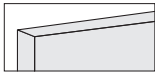

521
Blanc Sibérie



523
Huître



524
Gris Luton



525
Gravier



526
Foin



527
Corde



528
Limon



529
Ardoise



530
Noir abysse



531
Noir intense

BOIS + CDF NOIR - Chant noir apparent.

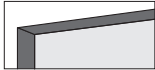

049
Chêne



033
Chêne cendré
gris



076
Chêne
graphite



334
Ecowood Xilo
2.0 Planked
Sand (18.22)



335
Ecowood Xilo
2.0 Planked
Grey (18.23)



333
Ecowood Xilo
2.0 Striped
Black (18.04)

BOIS SELECTION + CDF NOIR - Chant noir apparent.

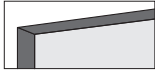

337
Orme
Américain



048
Cœur de
noyer



093
Noyer
"canaletto"
U.S.



101
Chêne fumé

PIERRE - MARBRE



240
Marbre blanc
Carrara



260
Marbre Grey
Stone



273
Pietra d'Avola

COMPOSITE MDI

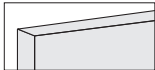

233
Blanc



234
Chameau



236
Vison



237
Gris



238
Noir



231
Devon



232
Surrey

R.I.G. BATHROOM

FINITIONS RÉALISABLES - ÉTAGÈRES

* Finition exclusive R.I.G. BATHROOM

FINITION
ÉTAGÈRES COULEURS / ESSENCES

EASYLAK+ - H 22 mm

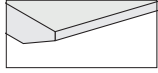

506 Blanc Cortina
507 Gris Leeds

LASERMAT + CDF NERO - H 12 / 19 mm - Chant noir apparent.

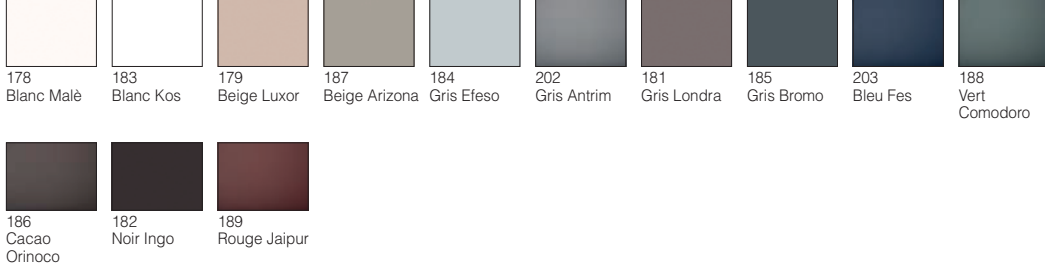
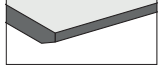

186 Cacao Orinoco
182 Noir Ingo
189 Rouge Jaipur

VERRE - H 6 mm

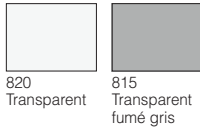
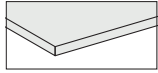

820 Transparent
815 Transparent fumé gris

SILCOLAK - H 22 mm

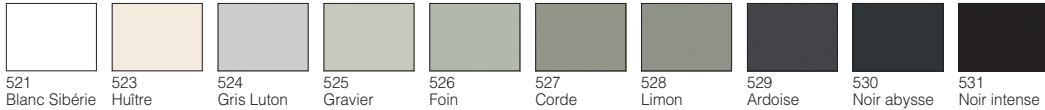
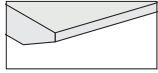

521 Blanc Sibérie
523 Huître
524 Gris Luton
525 Gravier
526 Foin
527 Corde
528 Limon
529 Ardoise
530 Noir abysse
531 Noir intense

BOIS + CDF NOIR - H 12 / 19 mm - Chant noir apparent.

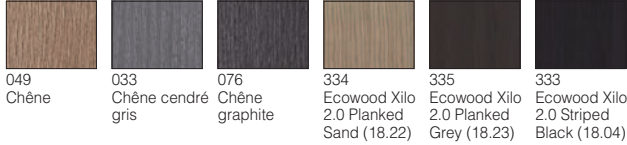
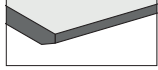

049 Chêne
033 Chêne cendré gris
076 Chêne graphite
334 Ecowood Xilo 2.0 Planked Sand (18.22)
335 Ecowood Xilo 2.0 Planked Grey (18.23)
333 Ecowood Xilo 2.0 Striped Black (18.04)

BOIS SELECTION + CDF NOIR - H 12 / 19 mm - Chant noir apparent.

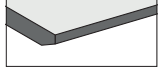

337 Orme Américain
048 Cœur de noyer
093 Noyer "canaletto" U.S.
101 Chêne fumé

CORIAN® - H 12 mm

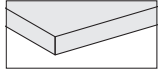

173 Blanc

CORIAN® EXTRA - H 12 mm

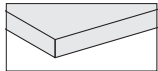

171 Gris Stratus semi-brillant

PIERRE - MARBRE - H 12 mm

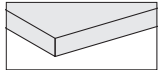

240 Marbre blanc Carrara
260 Marbre Grey Stone
273 Pietra d'Avola
955 Pierre lavique noire enneDue*

R.I.G. BATHROOM

FINITIONS RÉALISABLES - ÉTAGÈRES

* Finition exclusive R.I.G. BATHROOM

FINITION
ÉTAGÈRES

COULEURS / ESSENCES

COMPOSITE MDI - H 12 mm

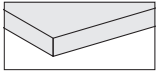

233
Blanc



234
Chameau



236
Vison



237
Gris



238
Noir



231
Devon



232
Surrey



* Finition exclusive R.I.G. BATHROOM

FINITION PLANS COULEURS / ESSENCES

EASYLAK+

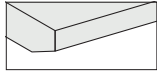

506 Blanc Cortina
507 Gris Leeds



LASERMAT + CDF NERO - H 12 mm - Chant noir apparent.

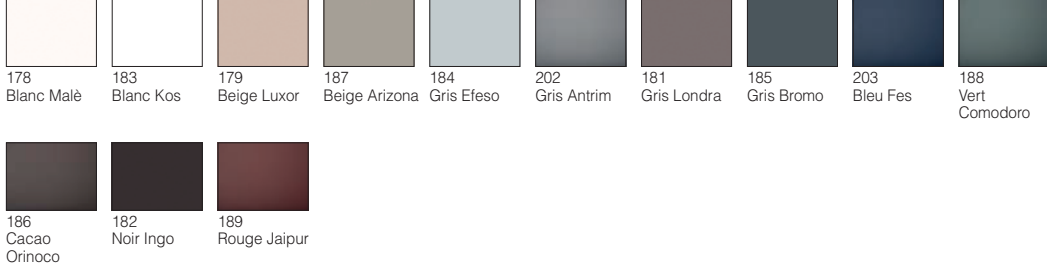
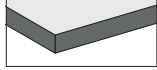

178 Blanc Malè
183 Blanc Kos
179 Beige Luxor
187 Beige Arizona
184 Gris Efeso
202 Gris Antrim
181 Gris Londra
185 Gris Bromo
203 Bleu Fes
188 Vert Comodoro

186 Cacao Orinoco
182 Noir Ingo
189 Rouge Jaipur



SILCOLAK

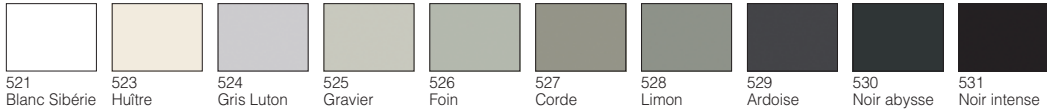
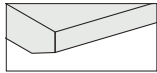

521 Blanc Sibérie
523 Hûître
524 Gris Luton
525 Gravier
526 Foin
527 Corde
528 Limon
529 Ardoise
530 Noir abysse
531 Noir intense



BOIS + CDF NOIR - H 12 mm - Chant noir apparent.

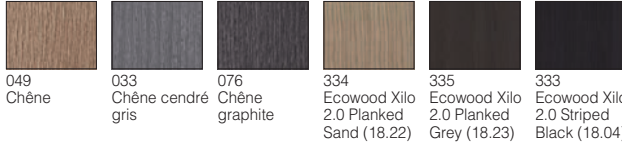
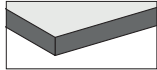

049 Chêne
033 Chêne cendré gris
076 Chêne graphite
334 Ecowood Xilo 2.0 Planked Sand (18.22)
335 Ecowood Xilo 2.0 Planked Grey (18.23)
333 Ecowood Xilo 2.0 Striped Black (18.04)



BOIS SELECTION + CDF NOIR - H 12 mm - Chant noir apparent.

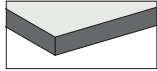

337 Orme Américain
048 Cœur de noyer
093 Noyer "canaletto" U.S.
101 Chêne fumé



CORIAN® - H 12 mm

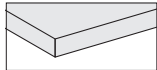

173 Blanc



CORIAN® EXTRA - H 12 mm

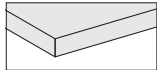

171 Gris Stratus semi-brillant



PIERRE - MARBRE - H 12 mm

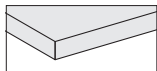

240 Marbre blanc Carrara
260 Marbre Grey Stone
273 Pietra d'Avola
955 Pierre lavique noire enneDue*



COMPOSITE MDI - H 12 mm

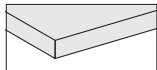

233 Blanc
234 Chameau
236 Vison
237 Gris
238 Noir
231 Devon
232 Surrey



R.I.G. BATHROOM

Rudimentary Interior Geometry
Design Mikal Harrsen

Modulares Badezimmerssystem.

Das Modul wurde speziell für den Einsatz in Badezimmern entwickelt, um sowohl Wand- als auch Inselkompositionen vorzuschlagen.

Bei Inselkompositionen befolgen Sie genau die Regeln des Abschnitts „Hinweise für den Planer“ und die spezifischen Angaben für jede Komponente.

Rahmenstrukturen (1), Stabilisatoren (2), Träger (3), Stange

Massiver Edelstahl AISI 304 (sofern auf den einzelnen Seiten der einzelnen Produkte nicht anders angegeben), pulverbeschichtet (schwarz gaufriert) oder naslackiert (Messing).

Regulierbare Füßchen aus Edelstahl

FARBEN: schwarz gaufriert, Messing.

Fachböden (4)

EASYLAK+ / SILCOLAK: Paneel aus mitteldichter Faserplatte MDF, mit geringem Formaldehydgehalt (zertifiziert Klasse E1, CARB P2 / TSCA Title VI). Der Fachboden hat sichtbare abgeschrägte Vorder- und Hinterkanten. Stärke 22mm, lackiert. LASERMAT + CDF SCHWARZ / HOLZ + CDF SCHWARZ / HOLZ SELECTION + CDF SCHWARZ: in umweltfreundliche, kompakt verdichtete Holzfaserverplatte (CDF - zertifiziert Klasse E1, CARB P2 / TSCA Title VI). Der Fachboden hat sichtbare abgeschrägte Vorder- und Hinterkanten. Sichtbare schwarze Kante, St. 12/19 mm. GLAS: Stärke 6 mm, gehärtet, mit geschliffener Kante poliert.

CORIAN® / MARMOR / STEIN / AGGLOMERAT MDI: Rechteckiges Fachboden St. 12 mm.

Max. Tragfähigkeit (die angegebenen Kapazitäten beziehen sich auf Module L 27,5 / L 55 / L 110 cm mit gleichmäßig verteilten Gewichten):

- Stärke 0,6 cm: max. 20 Kg

- Stärke 1,2 cm: max. 30 Kg

- Stärke 1,9 - 2,2 cm: max. 50 Kg

Waschtisch (5)

EASYLAK+ / SILCOLAK: Paneel aus mitteldichter Faserplatte MDF, mit geringem Formaldehydgehalt (zertifiziert Klasse E1, CARB P2 / TSCA Title VI). Der Fachboden hat sichtbare abgeschrägte Vorder- und Hinterkanten. Stärke 22mm, lackiert. LASERMAT + CDF SCHWARZ / HOLZ + CDF SCHWARZ / HOLZ SELECTION + CDF SCHWARZ: in umweltfreundliche, kompakt verdichtete Holzfaserverplatte (CDF - zertifiziert Klasse E1, CARB P2 / TSCA Title VI). Sichtbare schwarze Kante, St. 12 mm.

CORIAN® / MARMOR / STEIN / AGGLOMERAT MDI: Rechteckige Waschtischplatte St. 12 mm.

Max. Tragfähigkeit: siehe "Fachböden".

Schrank (6)

Aus Paneelen aus Spanplatte, Stärke 19 mm, mit geringem Formaldehydgehalt (zertifiziert Klasse E1, CARB P2 / TSCA Title VI), mit Melaminharzbeschichtung mit hoher Dichte. Vorder- und rückseitige Kante aus ABS in Ausführung.

Schubladen (7)

System LEGRABOX, mit rückseitiger Blende und Seitenblenden aus mattschwarz lackiertem Metall. Boden schwarze Melaminbeschichtung und Frontpaneel (der Innenschubladen) in melaminbeschichteter Ausführung wie Schrankelement.

Frontpaneele (8), Rückpaneele (9), Seitenteile (10)

EASYLAK+ / SILCOLAK: Paneel aus mitteldichter Faserplatte MDF, mit geringem Formaldehydgehalt (zertifiziert Klasse E1, CARB P2 / TSCA Title VI). Lackiert.

LASERMAT + CDF SCHWARZ / HOLZ + CDF SCHWARZ / HOLZ SELECTION + CDF SCHWARZ: in umweltfreundliche, kompakt verdichtete Holzfaserverplatte (CDF - zertifiziert Klasse E1, CARB P2 / TSCA Title VI). Sichtbare schwarze Kante.

MARMOR / STEIN / AGGLOMERAT MDI: Rechteckiges Paneel St. 12 mm (Seitenteile St. 10 mm).

Frontpaneele mit automatischem Druck-Öffnungssystem "TIP-ON".

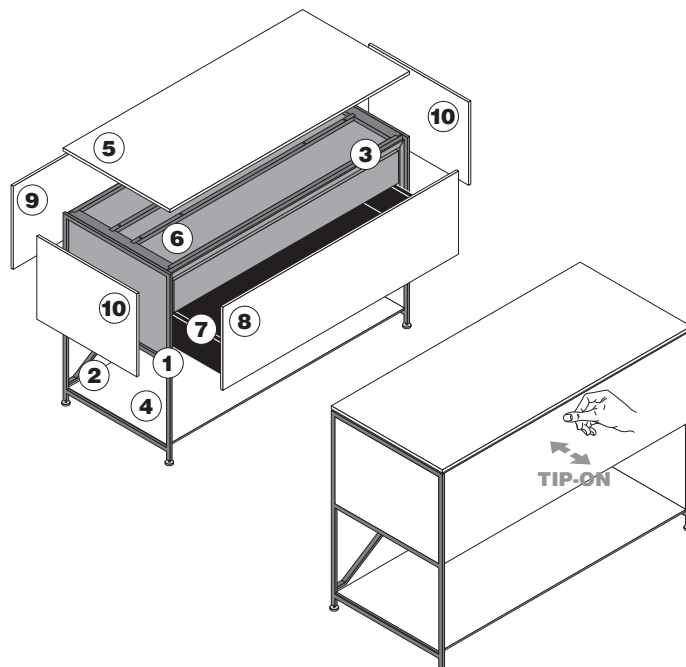

* Exklusive Ausführung für R.I.G. BATHROOM

AUSFÜHRUNG
FRONTEN

FARBEN / HOLZARTEN

EASYLAK+

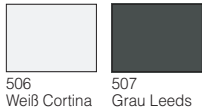
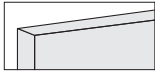

506 Weiß Cortina 507 Grau Leeds

LASERMAT + CDF SCHWARZ - Schwarze sichtbare Kante.

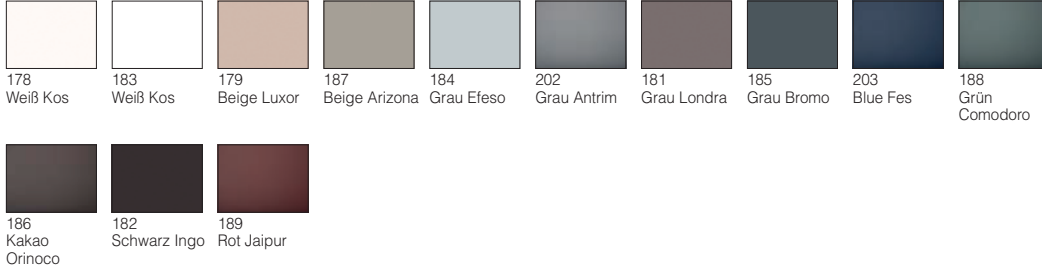

178 Weiß Kos 183 Weiß Kos 179 Beige Luxor 187 Beige Arizona 184 Grau Efeso 202 Grau Antrim 181 Grau Londra 185 Grau Bromo 203 Blue Fes 188 Grün Comodoro
186 Kakao Orinoco 182 Schwarz Ingo 189 Rot Jaipur

SILCOLAK

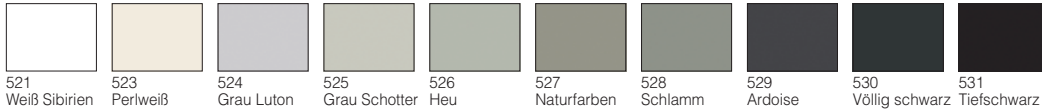
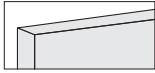

521 Weiß Sibirien 523 Perlweiß 524 Grau Luton 525 Grau Schotter 526 Heu 527 Naturfarben 528 Schlamm 529 Ardoise 530 Völlig schwarz 531 Tiefschwarz

HOLZ + CDF SCHWARZ - Schwarze sichtbare Kante.

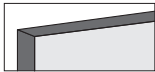

049 Eiche 033 Eiche Aschgrau 076 Eiche Grafitgrau 334 Ecowood Xilo 2.0 Planked Sand (18.22) 335 Ecowood Xilo 2.0 Planked Grey (18.23) 333 Ecowood Xilo 2.0 Striped Black (18.04)

HOLZ SELECTION + CDF SCHWARZ - Schwarze sichtbare Kante.

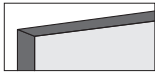

337 Amerikanische Ulme 048 Kern-Nussbaum 093 Nussbaum Canaletto U.S. 101 Räuchereiche

STEIN - MARMOR

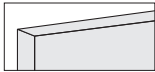

240 Carrara-Marmor weiß 260 Marmor Grey Stone 273 Stein Pietra D'Avola

AGGLOMERAT MDI

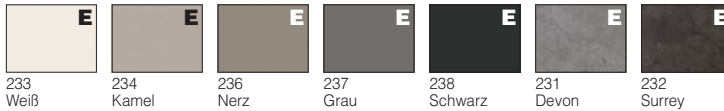
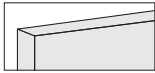

233 Weiß 234 Kamel 236 Nerz 237 Grau 238 Schwarz 231 Devon 232 Surrey

R.I.G. BATHROOM

ERHÄLTICHE AUSFÜHRUNGEN - FACHBÖDEN

* Exklusive Ausführung für R.I.G. BATHROOM

AUSFÜHRUNG
FACHBÖDEN

FARBEN / HOLZARTEN

EASYLAK+ - H 22 mm

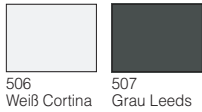
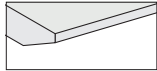

506 Weiß Cortina
507 Grau Leeds

LASERMAT + CDF SCHWARZ - H 12 / 19 mm - Schwarze sichtbare Kante.

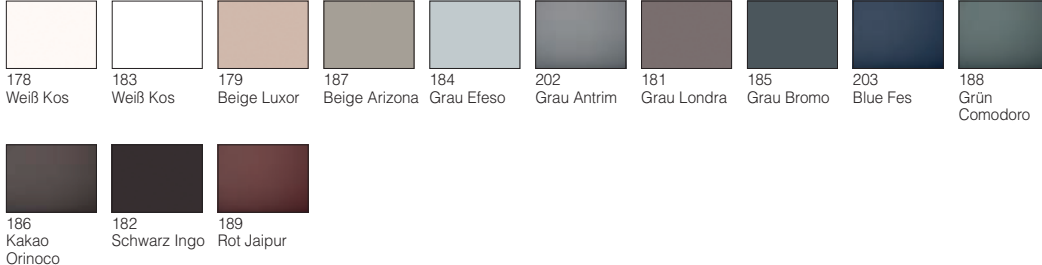
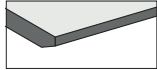

186 Kakao Orinoco
182 Schwarz Ingo
189 Rot Jaipur

GLAS - H 6 mm

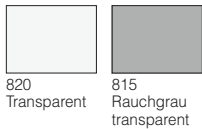
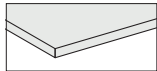

820 Transparent
815 Rauchgrau transparent

SILCOLAK - H 22 mm

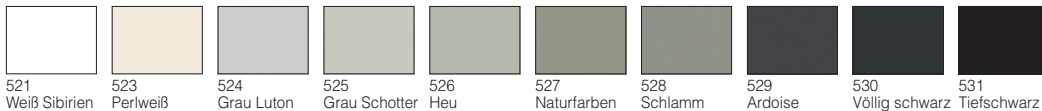
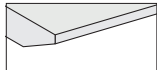

521 Weiß Sibirien
523 Perlweiß
524 Grau Luton
525 Grau Schotter
526 Heu
527 Naturfarben
528 Schlamm
529 Ardoise
530 Völlig schwarz
531 Tiefschwarz

HOLZ + CDF SCHWARZ - H 12 / 19 mm - Schwarze sichtbare Kante.

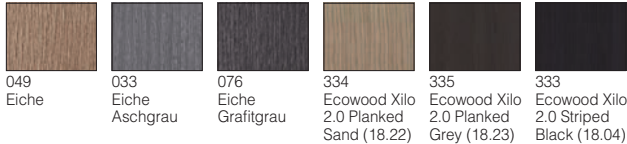
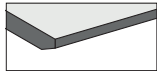

049 Eiche
033 Eiche Aschgrau
076 Eiche Grafitgrau
334 Ecowood Xilo 2.0 Planked Sand (18.22)
335 Ecowood Xilo 2.0 Planked Grey (18.23)
333 Ecowood Xilo 2.0 Striped Black (18.04)

HOLZ SELECTION + CDF SCHWARZ - H 12 / 19 mm - Schwarze sichtbare Kante.

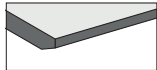

337 Amerikanische Ulme
048 Kern-Nussbaum
093 Nussbaum Canaletto U.S.
101 Räuchereiche

CORIAN® - H 12 mm

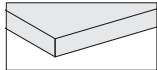

173 Weiß

CORIAN® EXTRA - H 12 mm

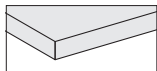

171 Grau Stratus halbgläzend

STEIN - MARMOR - H 12 mm

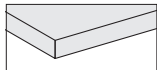

240 Carrara-Marmor weiß
260 Marmor Grey Stone
273 Stein Pietra D'Avola
955 Schwarzer Lavastein enneDue*

R.I.G. BATHROOM

ERHÄLTICHE AUSFÜHRUNGEN - FACHBÖDEN

* Exklusive Ausführung für R.I.G. BATHROOM

AUSFÜHRUNG
FACHBÖDEN

FARBEN / HOLZARTEN

AGGLOMERAT MDI - H 12 mm

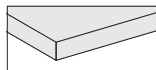

233
Weiß



234
Kamel



236
Nerz



237
Grau



238
Schwarz



231
Devon



232
Surrey



* Exklusive Ausführung für R.I.G. BATHROOM

AUSFÜHRUNG

WASCHTISCHPLATTEN FARBEN / HOLZARTEN

EASYLAK+

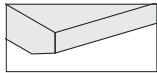

506
Weiß Cortina



507
Grau Leeds



LASERMAT + CDF SCHWARZ - H 12 mm - Schwarze sichtbare Kante.

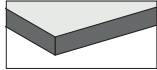

178
Weiß Kos



183
Weiß Kos



179
Beige Luxor



187
Beige Arizona



184
Grau Efeso



202
Grau Antrim



181
Grau Londra



185
Grau Bromo



203
Blue Fes



188
Grün
Comodoro



186
Kakao
Orinoco



182
Schwarz Ingo



189
Rot Jaipur



SILCOLAK

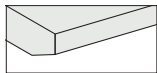

521
Weiß Sibirien



523
Perlweiß



524
Grau Luton



525
Grau Schotter



526
Heu



527
Naturfarben



528
Schlamm



529
Ardoise



530
Völlig schwarz



531
Tiefschwarz



HOLZ + CDF SCHWARZ - H 12 mm - Schwarze sichtbare Kante.

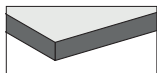

049
Eiche



033
Eiche
Aschgrau



076
Eiche
Grafitgrau



334
Ecowood Xilo
2.0 Planked
Sand (18.22)



335
Ecowood Xilo
2.0 Planked
Grey (18.23)



333
Ecowood Xilo
2.0 Striped
Black (18.04)



HOLZ SELECTION + CDF SCHWARZ - H 12 mm - Schwarze sichtbare Kante.

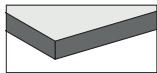

337
Amerikanische
Ulme



048
Kern-
Nussbaum



093
Nussbaum
Canaletto
U.S.



101
Räuhereiche



CORIAN® - H 12 mm

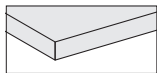

173
Weiß



CORIAN® EXTRA - H 12 mm

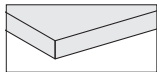

171
Grau Stratus
halbgläzend



STEIN - MARMOR - H 12 mm

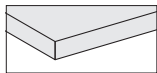

240
Carrara-
Marmor weiß



260
Marmor Grey
Stone



273
Stein Pietra
D'Avola



955
Schwarzer
Lavastein
enneDue*



AGGLOMERAT MDI - H 12 mm

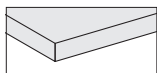

233
Weiß



234
Kamel



236
Nerz



237
Grau



238
Schwarz



231
Devon



232
Surrey



R.I.G. BATHROOM

Rudimentary Interior Geometry
Design Mikal Harrsen

Sistema baño componible.

El kit de fijación se ha estudiado especialmente para utilización en cuartos de baño, para obtener composiciones de pared e isla.

Para eventuales instalaciones en isla, seguir con atención las reglas evidenciadas en la sección "notas para el diseño" y en las indicaciones específicas de cada componente.

Estructuras (1), estabilizadores (2), soportes (3), astas

Acero inox AISI 304 pleno (a menos que se indique otra cosa en las páginas específicas de cada producto), barnizado en polvo (negro gofrado) o barnizado en líquido (latón).

Pies ajustables en acero inox.

COLORES: negro gofrado, latón.

Estantes (4)

EASYLAK+ / SILCOLAK: realizado en panel de aglomerado de madera MDF medium density, con bajo contenido de formaldehído (certificado clase E1, CARB P2 / TSCA Title VI). Estante caracterizado por chaflandes inclinados a vista en el lado frontal y en el lado trasero. Grosor 22 mm, lacado

LASERMAT + CDF NEGRO / MADERA + CDF NEGRO / MADERA SELECTION + CDF NEGRO: realizado en panel ecológico en fibra de madera con alta densidad (CDF - certificado clase E1, CARB P2 / TSCA Title VI). Estante caracterizado por chaflandes inclinados a vista en el lado frontal y en el lado trasero. Grosor 12 / 19 mm, borde negro a vista.

VIDRIO: grosor 6 mm, templado con canto hilo brillante.

CORIAN® / MÁRMOL / PIEDRA / COMPUESTO MDI: estante cuadrado grosor 12 mm.

Capacidad máxima de carga (los caudales indicados se refieren a secciones L 27,5 / L 55 / L 110 cm, con pesos distribuidos uniformemente):

- grosor 0,6 cm: máx 20 kg
- grosor 1,2 cm: máx 30 kilos
- grosor 1,9 - 2,2 cm: máx 50 kilos

Top (5)

EASYLAK+ / SILCOLAK: realizado en panel de aglomerado de madera MDF medium density, con bajo contenido de formaldehído (certificado clase E1, CARB P2 / TSCA Title VI). Estante caracterizado por chaflandes inclinados a vista en el lado frontal y en el lado trasero. Grosor 22 mm, lacado

LASERMAT + CDF NEGRO / MADERA + CDF NEGRO / MADERA SELECTION + CDF NEGRO: realizado en panel ecológico en fibra de madera con alta densidad (CDF - certificado clase E1, CARB P2 / TSCA Title VI). Grosor 12 mm, borde negro a vista.

CORIAN® / MÁRMOL / PIEDRA / COMPUESTO MDI: encimera cuadrada grosor 12 mm.

Capacidad máxima de carga: ver "Estantes".

Contenedor (6)

Realizados en paneles de partículas de madera grosor 19 mm, hidrófugos, con bajo contenido de formaldehído (certificado clase E1, CARB P2/ TSCA Title VI) melamínico con papeles con alto gramaje tratados con resinas melamínicas. Borde delantero y trasero en ABS del mismo color.

Cajones (7)

Sistema LEGRABOX, con bordes laterales y posteriores en metal lacado en color negro mate. Fondo en madera ennoblecida negro y frente (cajones internos) en madera ennoblecida acabado mueble contenedor.

Frentes (8), paneles traseros (9), costados laterales (10)

EASYLAK+ / SILCOLAK: realizado en panel de aglomerado de madera MDF medium density, con bajo contenido de formaldehído (certificado clase E1, CARB P2 / TSCA Title VI). Lacado

LASERMAT + CDF NEGRO / MADERA + CDF NEGRO / MADERA SELECTION + CDF NEGRO: realizado en panel ecológico en fibra de madera con alta densidad (CDF - certificado clase E1, CARB P2 / TSCA Title VI). Borde negro a vista.

MÁRMOL / PIEDRA / COMPUESTO MDI: panel cuadrado grosor 12 mm (costados laterales grosor 10 mm).

Frentes con apertura automática asistida "TIP-ON".

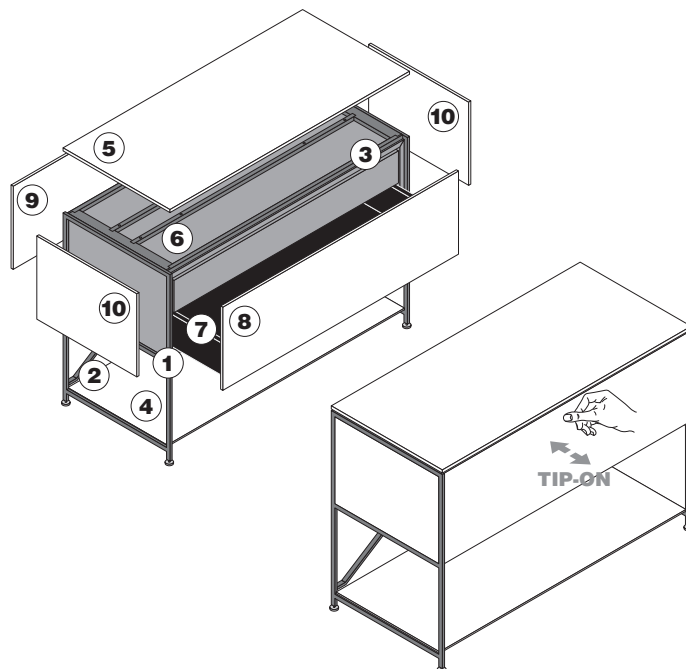

R.I.G. BATHROOM

ACABADOS REALIZABLES - FRENTEROS

MUEBLE
CONTENEDOR
ENNOBLECIDO.



604
Negro Sablé *

* Acabado exclusivo R.I.G. BATHROOM

ACABADO
FRENTEROS

COLORES / MADERAS

EASYLAK+



506
Blanco
Cortina



507
Gris Leeds

LASERMAT + CDF NEGRO - Borde negro a vista



178
Blanco Malè



183
Blanco Kos



179
Beige Luxor



187
Beige Arizona



184
Gris Efeso



202
Gris Antrim



181
Gris Londra



185
Gris Bromo



203
Azul Fes



188
Verde
Comodoro



186
Cacao
Orinoco



182
Negro Ingo



189
Rojo Jaipur

SILCOLAK

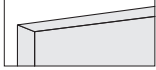

521
Blanco
Siberia



523
Ostra



524
Gris Luton



525
Grava



526
Heno



527
Cuerda



528
Limo



529
Pizarra



530
Negro Abismo



531
Negro Intenso

MADERA + CDF NEGRO - Borde negro a vista



049
Roble



033
Roble ceniza



076
Roble grafito



334
Ecowood Xilo
2.0 Planked
Sand (18.22)



335
Ecowood Xilo
2.0 Planked
Grey (18.23)



333
Ecowood Xilo
2.0 Striped
Black (18.04)

MADERA SELECTION + CDF NEGRO - Borde negro a vista



337
Olmo
americano



048
Alma de
nogal



093
Nogal canaletto
(americano)
U.S.



101
Roble
ahumado

PIEDRA - MÁRMOL

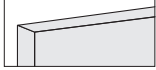

240
Mármol
blanco
Carrara



260
Mármol Grey
Stone



273
Pietra d'Avola

COMPUESTO MDI

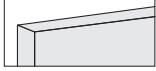

233
Blanco



234
Camello



236
Visón



237
Gris



238
Negro



231
Devon



232
Surrey

R.I.G. BATHROOM

ACABADOS REALIZABLES - ESTANTES

* Acabado exclusivo R.I.G. BATHROOM

ACABADO
ESTANTES

COLORES / MADERAS

EASYLAK+ - H 22 mm

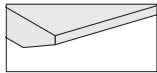

506
Blanco
Cortina



507
Gris Leeds

LASERMAT + CDF NEGRO - H 12 / 19 mm - Borde negro a vista.

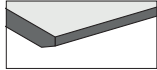

178
Blanco Malè



183
Blanco Kos



179
Beige Luxor



187
Beige Arizona



184
Gris Efeso



202
Gris Antrim



181
Gris Londra



185
Gris Bromo



203
Azul Fes



188
Verde
Comodoro



186
Cacao
Orinoco



182
Negro Ingo



189
Rojo Jaipur

VIDRIO - H 6 mm

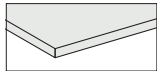

820
Transparente



815
Transparente
fumè gris

SILCOLAK - H 22 mm

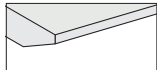

521
Blanco
Siberia



523
Ostra



524
Gris Luton



525
Grava



526
Heno



527
Cuerda



528
Limo



529
Pizzarra



530
Negro Abismo



531
Negro Intenso

MADERA + CDF NEGRO - H 12 / 19 mm - Borde negro a vista.

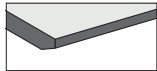

049
Roble



033
Roble ceniza



076
Roble grafito



334
Ecowood Xilo
2.0 Planked
Sand (18.22)



335
Ecowood Xilo
2.0 Planked
Grey (18.23)



333
Ecowood Xilo
2.0 Striped
Black (18.04)

MADERA SELECTION + CDF NEGRO - H 12 / 19 mm - Borde negro a vista.

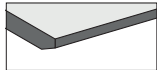

337
Olmo
americano



048
Alma de
nogal



093
Nogal canaletto
(americano)
U.S.



101
Roble
ahumado

CORIAN® - H 12 mm

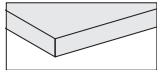

173
Blanco

CORIAN® EXTRA - H 12 mm

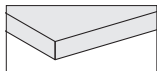

171
Gris Stratus
semi-brillante

PIEDRA - MÁRMOL - H 12 mm

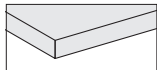

240
Mármol
blanco
Carrara



260
Mármol Grey
Stone



273
Pietra d'Avola



955
Piedra
lávica negra
enneDue *

R.I.G. BATHROOM

ACABADOS REALIZABLES - ESTANTES

* Acabado exclusivo R.I.G. BATHROOM

ACABADO
ESTANTES

COLORES / MADERAS

COMPUESTO MDI - H 12 mm

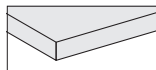

233
Blanco



234
Camello



236
Visón



237
Gris



238
Negro



231
Devon



232
Surrey



SOBRE
ENCIMERA
apoyado

* Acabado exclusivo R.I.G. BATHROOM

ACABADO
ENCIMERAS

COLORES / MADERAS

EASYLAK+

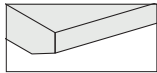

506
Blanco
Cortina



507
Gris Leeds



LASERMAT + CDF NEGRO - H 12 mm - Borde negro a vista.

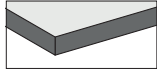

178
Blanco Malè



183
Blanco Kos



179
Beige Luxor



187
Beige Arizona



184
Gris Efeso



202
Gris Antrim



181
Gris Londra



185
Gris Bromo



203
Azul Fes



188
Verde
Comodoro



186
Cacao
Orinoco



182
Negro Ingo



189
Rojo Jaipur



SILCOLAK

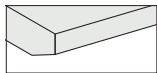

521
Blanco
Siberia



523
Ostra



524
Gris Luton



525
Grava



526
Heno



527
Cuerda



528
Limo



529
Pizzarra



530
Negro Abismo



531
Negro Intenso



MADERA + CDF NEGRO - H 12 mm - Borde negro a vista.

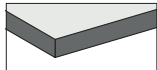

049
Roble



033
Roble ceniza



076
Roble grafito



334
Ecowood Xilo
2.0 Planked
Sand (18.22)



335
Ecowood Xilo
2.0 Planked
Grey (18.23)



333
Ecowood Xilo
2.0 Striped
Black (18.04)



MADERA SELECTION + CDF NEGRO - H 12 mm - Borde negro a vista.

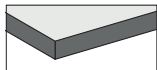

337
Olmo
americano



048
Alma de
nogal



093
Nogal canaletto
(americano)
U.S.



101
Roble
ahumado



CORIAN® - H 12 mm

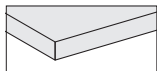

173
Blanco



CORIAN® EXTRA - H 12 mm

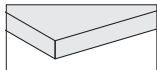

171
Gris Stratus
semi-brillante



PIEDRA - MÁRMOL - H 12 mm

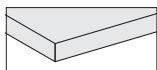

240
Mármol
blanco
Carrara



260
Mármol Grey
Stone



273
Pietra d'Avola



955
Piedra
lávica negra
enneDue*



COMPUESTO MDI - H 12 mm

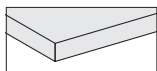

233
Blanco



234
Camello



236
Visón



237
Gris



238
Negro



231
Devon



232
Surrey

