

XILA BATH

Design C.R.S. Boffi

Sistema modulare di contenitori base sospesi senza maniglia. L'impugnatura (e l'apertura) dei frontali avviene grazie allo smusso presente sulla parte superiore. I piani specifici, dotati di frontalino inferiore arretrato in finitura, completano il mobile con effetto fascia maniglia.

Piano (1)

Piano squadrato con frontalino inferiore in finitura, allestibile con lavabi sopra-piano da appoggio, sopra-piano da incasso, sottopiano da incasso o filopiano stampato. SPESSORE: 12 - 15 - 20 mm (+ frontalino inferiore H 50 mm)

PROFONDITÀ: 500 mm

LAVABI COMPATIBILI: sopra-piano da appoggio, sopra-piano da incasso, sottopiano da incasso e filopiano stampato (filopiano stampato in Cristalplant® solo su piani in Cristalplant® - filopiano stampato in Corian® solo su piani in Corian® - sottopiano da incasso NON compatibile con piani in Lasermat).

FINITURE spessore 12 mm (+ frontalino inferiore H 50 mm): composito Dekton®.

FINITURE spessore 15 mm (+ frontalino inferiore H 50 mm): Cristalplant®.

FINITURE spessore 20 mm (+ frontalino inferiore H 50 mm): Corian®, pietra / marmo / granito / composito (Corian® compatibile solo con lavabi sopra-piano da appoggio in Ceramilux® o filopiano stampato in Corian®).

Cassetti (2)

Sistema LEGRABOX, con spondine laterali e posteriore in metallo verniciato in colore nero opaco. Fondo in nobilitato nero. Frontale cassetti interni in nobilitato finitura contenitore.

Ante e frontali (3)

Realizzate in finitura, spessore 23 mm con smusso superiore.

Contenitore (4)

Realizzato in pannelli di particelle di legno di spessore 19 mm, idrofughi, a basso contenuto di formaldeide (certificato classe E1, CARB P2 / TSCA Title VI) nobilitato con carte ad alta grammatura trattate con resine melamminiche. Bordo anteriore e posteriore in ABS in tinta.

ALTEZZA FIANCO: 300 - 470 mm (entrambe compatibili con lavabi Boffi sopra-piano da incasso / sottopiano da incasso / filopiano stampato).

ALTEZZA CON FRONTALE: 315 - 485 mm.

PROFONDITÀ FIANCO: 470 mm.

PROFONDITÀ CON FRONTALE: 495 mm.

LARGHEZZA MODULO: 300 - 450 - 600 - 900 - 1200 mm.

Pannelli terminali (5)

Realizzati in finitura, spessore 23 mm. (Spessore 20 mm per pietra / marmo / granito).

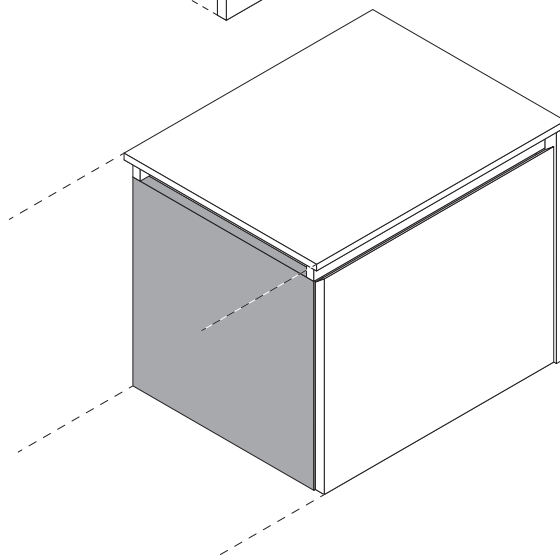
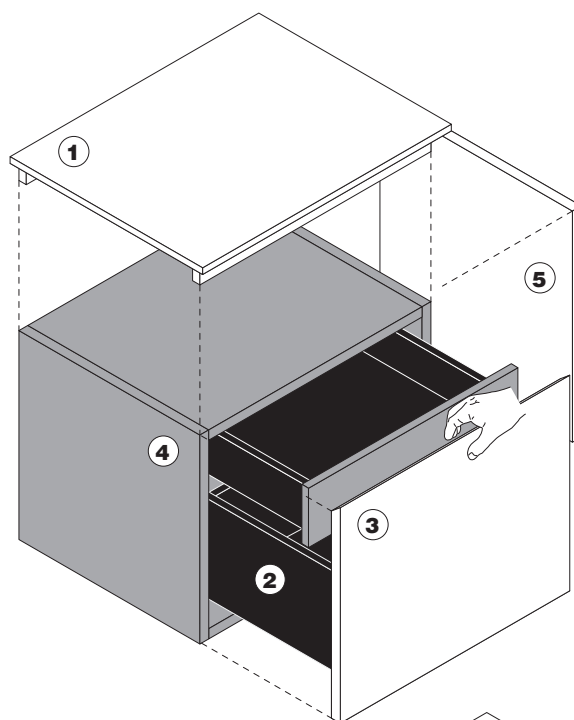



606
Olmo (effetto
poro aperto)



610
Larice
termico
(effetto poro
aperto)



608
Rovere grafite
(effetto poro
aperto)

FINITURA
FRONTALI

COLORI / ESSENZE

EASYLAK+

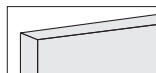

506
Bianco
Cortina



507
Grigio Leeds

ECOLAK

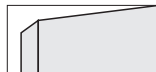

510
Bianco artico



129
Magnolia



513
Nuvola



024
Ciottolo



512
Avena



025
Écru



023
Fango



515
Basalto



517
Carbone



027
Nero

SILCOLAK

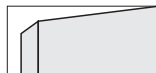

521
Bianco
Siberia



523
Ostrica



524
Grigio Luton



525
Ghiaia



526
Fieno



527
Corda



528
Limo



529
Ardesia



530
Abisso



531
Nero Intenso

LEGNO



049
Rovere



033
Rovere
cenere



076
Rovere grafite



334
Ecowood Xilo
2.0 Planked
Sand (18.22)



335
Ecowood Xilo
2.0 Planked
Grey (18.23)



333
Ecowood Xilo
2.0 Striped
Black (18.04)

POLIESTERE

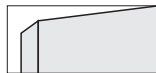

003
Bianco



129
Magnolia



005
Grigio RAL
7038



024
Ciottolo



063
Sabbia



113
Verde caligo



004
Grigio



107
Rosso Petra



117
Blu Jodhpur



027
Nero

LEGNO SELECTION

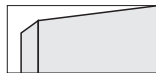

337
Olmo
americano



048
Noce colore



093
Noce
canaletto U.S.



101
Rovere
affumicato

METALS

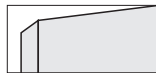

198
Bianco



934
Aluminium



197
Zinco+



195
Ottone
Vintage



196
Rame+



192
Titanio



191
Piombo

CORIAN®

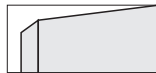

173
Bianco

LEGNO MASSELLO



058
Noce LIGHT
canaletto
"taglio sega"



057
Abete "antico"
grigio



066
Olmo
americano
SW



067
Frassino olivato
termotrattato SW



102
Rovere tinto
affumicato
SW

LEGNO EXCLUSIVE



077
Abonos fossil
oak



FINITURA PIANI COLORI / ESSENZE

LAVABI

CRISTALPLANT® - H 15 + 50 mm

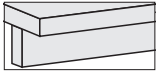

Bianco



CORIAN® - H 20 + 50 mm



173
Bianco



PIETRA - MARMO - GRANITO - H 20 + 50 mm



240
Marmo bianco
Carrara



250
Pietra Serena



257
Quarzite
Silver



199
Granito Nero
Assoluto
Zimbabwe



261
Marmo
Emperador
Dark



254
Granito Black
Cosmic



259
Quarzite
Calacatta



260
Marmo Grey
Stone



273
Pietra d'Avola



274
Pietra Crema
d'Orcia



266
Marmo bianco
Carrara
Lithoverde®



265
Marmo Gris
du Marais
Lithoverde®



267
Pietra d'Avola
Lithoverde®

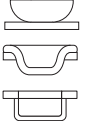

COMPOSITO DEKTON® - H 12 / 20 + 50 mm

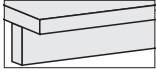

455
Beige Edora



453
Nero Sirius



454
Bianco Zenith



451
Grigio Strato



459
Marrone
Galema



461
Domoos



462
Keranium



460
Kelya

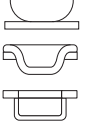
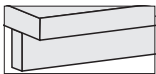

XILA BATH

Design C.R.S. Boffi

Wall hung, modular base units without handle. The tops have a specific recessed finished band on the bottom, which create an handle-rail effect. This detail, in combination with the bevelled edge of the doors, will offer the grip needed to open the door fronts.

Top (1)

The square-edged tops, with finished lower front, can be fitted with top-mounted, built-in, under-mounted or moulded flush-mounted washbasins.

THICKNESS: 12 - 15 - 20 mm (+ lower band H 50 mm)

DEPTH: 500 mm

COMPATIBLE WASHBASINS: top-mounted, built-in, under-mounted and moulded flush-mounted (moulded flush-mounted washbasins in Cristalplant® on tops in Cristalplant® only - moulded flush-mounted washbasins in Corian® on tops in Corian® only - under-mounted NOT compatible with tops in Lasermat).

FINISHES for 12 mm thick tops (+ lower front H 50 mm): Dekton®.

FINISHES for 15 mm thick tops (+ lower front H 50 mm): Cristalplant®.

FINISHES for 20 mm thick tops (+ lower front H 50 mm): Corian®, stone / marble / granite / composite (Corian® compatible only with top-mounted washbasins in Ceramilux® or moulded flush-mounted washbasins in Corian®).

Drawers (2)

LEGRABOX series with sides and back in varnished matt black metal. Bottom in black melamine. Front of internal drawers in melamine, same finish as carcass.

Doors and front panels (3)

Finished, thickness 23 mm, with upper bevelled edge.

Unit (4)

It's made of 19 mm thick wood particle board panels, waterproof, with low formaldehyde emission (class E1, CARB P2 / TSCA Title VI certified), treated with high performance melamine resin. Front and back edges in ABS, same colour

SIDE PANEL HEIGHT: 300 - 470 mm (both compatible with built-in / under-mounted / moulded flush-mounted Boffi washbasins).

HEIGHT INCLUDING DOOR: 315 - 485 mm.

SIDE PANEL DEPTH: 470 mm.

DEPTH INCLUDING DOOR: 495 mm.

MODULE WIDTH: 300 - 450 - 600 - 900 - 1200 mm.

End panels (5)

They are in finish, 23 mm. thick (20 mm thick for stone / marble / granite panels).

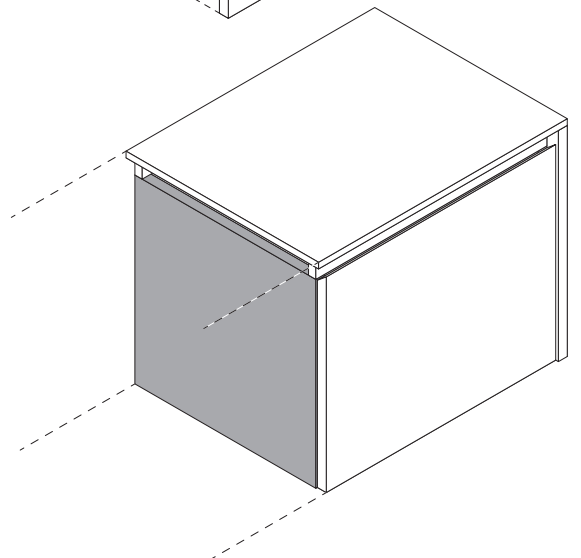
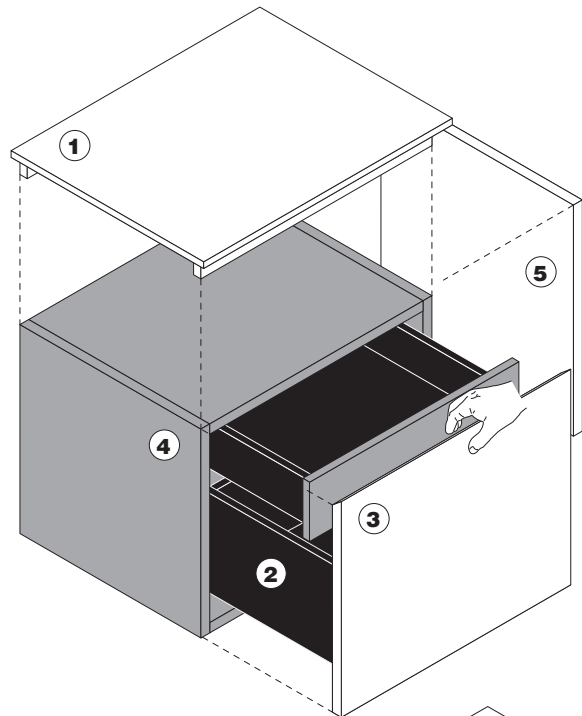



606
Elm (open-
pore effect)



610
Thermo-
treated larch
wood (open
pore effect)



608
Grey-graphite
oak (open
pore effect)

FRONT PANELS
FINISH

COLOURS / SPECIES

EASYLAK+



506
Cortina white



507
Leeds grey

ECOLAK



510
Arctic white



129
Magnolia



513
Cloud colour



024
Pebble grey



512
Oat colour



025
Écru



023
Mud



515
Basalt grey



517
Charcoal



027
Black

SILCOLAK



521
Siberia white



523
Oyster-pearl



524
Luton grey



525
Gravel grey



526
Hay



527
Rope-colour



528
Silt



529
Slate grey



530
Abyss black



531
Jet black

WOOD

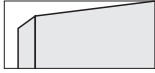

049
Oak



033
Ash-grey oak



076
Grey-graphite
oak



334
Ecowood Xilo
2.0 Planked
Sand (18.22)



335
Ecowood Xilo
2.0 Planked
Grey (18.23)



333
Ecowood Xilo
2.0 Striped
Black (18.04)

POLYESTER

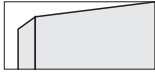

003
White



129
Magnolia



005
Grey RAL
7038



024
Pebble grey



063
Sand



113
Caligo green



004
Grey



107
Petra red



117
Jodhpur blue



027
Black

WOOD SELECTION

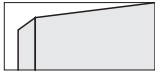

337
American elm



048
Core walnut



093
Canaletto
walnut U.S.



101
Smoked oak

METALS



198
White



934
Aluminium



197
Zinc+



195
Vintage brass



196
Copper+



192
Titanium



191
Lead

CORIAN®

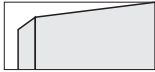

173
White

SOLID WOOD

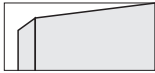

058
LIGHT Canaletto
walnut, "sawn"
effect



057
"Old" grey
pinewood



066
American elm
SW



067
Thermo-treated
Olivato ash
wood SW



102
Smoked dyed
oak SW

WOOD EXCLUSIVE



077
Abonos fossil
oak



TOPS FINISH

COLOURS / SPECIES

WASHBASINS

CRISTALPLANT® - H 15 + 50 mm

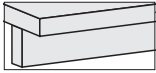

White



CORIAN® - H 20 + 50 mm



173
White



STONE - MARBLE - GRANITE - H 20 + 50 mm

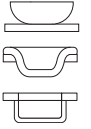
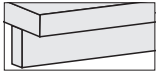

DEKTON® COMPOSITE - H 12 / 20 + 50 mm

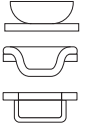
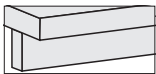
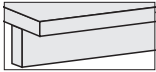

XILA BATH

Design C.R.S. Boffi

Système modulaire de bases suspendues sans poignée. La prise de main (et l'ouverture) des façades s'effectue grâce au chanfrein présent sur la partie supérieure. Les plans spécifiques, dotés de petite façade inférieure reculée, selon finitions disponibles, complètent le meuble avec effet poignée-bandeau.

Plan (1)

Plan avec chant droit avec petite façade inférieure selon les finitions disponibles, aménageable avec lavabos sur plan d'appui, sur plan à encastrer, sous plan à encastrer ou affleurants moulés.

ÉPAISSEUR: 12 - 15 - 20 mm (+ petite façade inférieure H 50 mm)

PROFONDEUR: 500 mm

LAVABOS COMPATIBLES: sur plan d'appui, sur plan à encastrer, sous plan à encastrer et affleurant moulé (affleurant moulé en Cristalplant® uniquement sur plans en Cristalplant® - affleurant moulé en Corian® uniquement sur plans en Corian® - sous plan à encastrer NON compatible avec plans en Lasermat).

FINITIONS épaisseur 15 mm (+ petite façade inférieure H 50 mm): composite Dekton®.

FINITIONS épaisseur 15 mm (+ petite façade inférieure H 50 mm): Cristalplant®.

FINITIONS épaisseur 20 mm (+ petite façade inférieure H 50 mm): Corian®, pierre / marbre / granite / composite (Corian® compatible uniquement avec lavabos sur plan d'appui en Ceramilux® ou affleurant moulé en Corian®).

Tiroirs (2)

Système LEGRABOX, avec rebords latéraux et arrière en métal peint en couleur noir mat. Fond en mélaminé noir. Façades tiroirs internes en mélaminé finition caisson.

Portes et façades (3)

Réalisées selon les finitions disponibles, épaisseur 23 mm, avec chanfrein supérieur.

Caisson (4)

Réalisé en panneaux de particules de bois d'épaisseur 19 mm, hydrofuges, à faible teneur en formaldéhyde (certifié classe E1 / CARB P2 / TSCA Title VI) mélaminé avec papiers à haute densité traités avec des résines mélaminiques. Chant avant et arrière en ABS de la même couleur.

HAUTEUR CÔTÉ: 300 - 470 mm (les deux compatibles avec lavabos Boffi sur plan à encastrer / sous plan à encastrer / affleurants moulés).

HAUTEUR AVEC FAÇADE: 315 - 485 mm.

PROFONDEUR CÔTÉ: 470 mm.

PROFONDEUR AVEC FAÇADE: 495 mm.

LARGEUR MODULE: 300 - 450 - 600 - 900 - 1200 mm.

Panneaux d'extrémité (5)

Réalisés selon les finitions disponibles, épaisseur 23 mm (Épaisseur 20 mm pour pierre / marbre / granite).

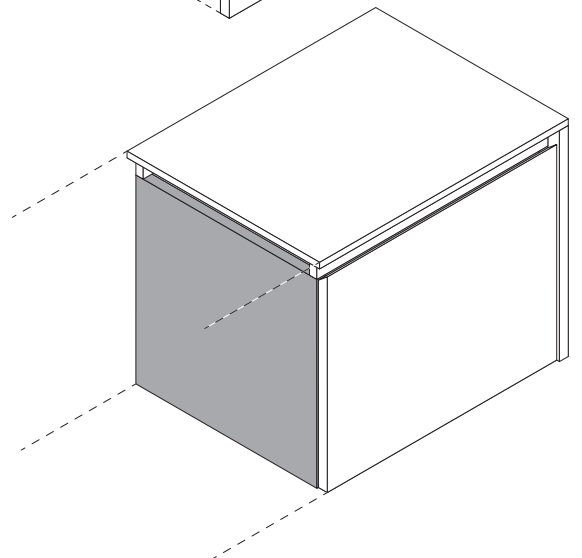
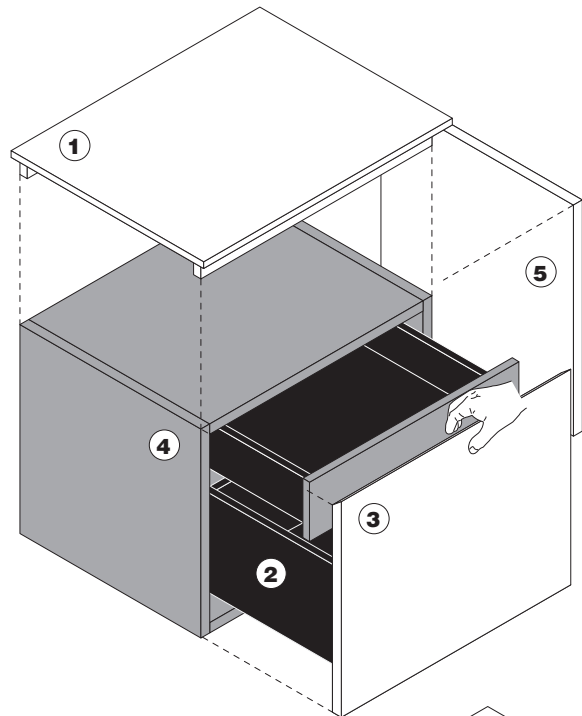



606
Orme (effet
pores
ouverts)

610
Mélèze
thermique
(effet pores
ouverts)

608
Chêne
graphite
(effet pores
ouverts)

FINITION FAÇADES COULEURS / ESSENCES

EASYLAK+

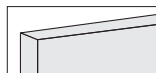

506
Blanc Cortina

507
Gris Leeds

ECOLAK

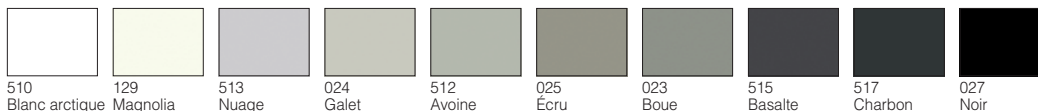
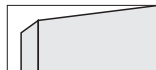

510
Blanc arctique

129
Magnolia

513
Nuage

024
Galet

512
Avoine

025
Écru

023
Boue

515
Basalte

517
Charbon

027
Noir

SILCOLAK

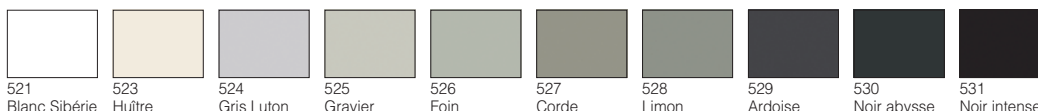

521
Blanc Sibérie

523
Huître

524
Gris Luton

525
Gravier

526
Foin

527
Corde

528
Limon

529
Ardoise

530
Noir abysse

531
Noir intense

BOIS



049
Chêne

033
Chêne cendré
gris

076
Chêne
graphite

334
Ecowood Xilo
2.0 Planked
Sand (18.22)

335
Ecowood Xilo
2.0 Planked
Grey (18.23)

333
Ecowood Xilo
2.0 Striped
Black (18.04)

POLYESTER

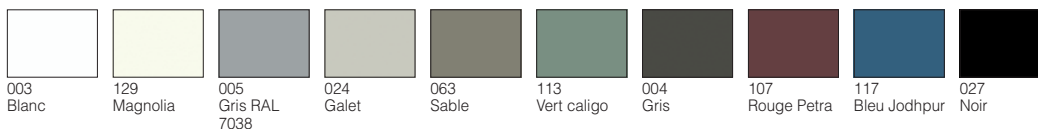

003
Blanc

129
Magnolia

005
Gris RAL
7038

024
Galet

063
Sable

113
Vert caligo

004
Gris

107
Rouge Petra

117
Bleu Jodhpur

027
Noir

BOIS SELECTION



337
Orme
Américain

048
Cœur de
noyer

093
Noyer
"canaletto"
U.S.

101
Chêne fumé

METALS



198
Blanc

934
Aluminium

197
Zinc+

195
Laiton Vintage

196
Cuivre+

192
Titane

191
Plomb

CORIAN®

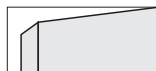

173
Blanc

BOIS MASSIF

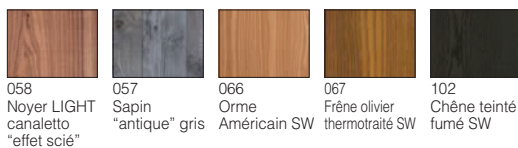

058
Noyer LIGHT
canaletto
"effet scié"

057
Sapin
"antique" gris

066
Orme
Américain SW

067
Frêne olivier
thermotraité SW

102
Chêne teinté
fumé SW

BOIS EXCLUSIVE



077
Abonos fossil
oak



FINITION PLANS COULEURS / ESSENCES

LAVABOS

CRISTALPLANT® - H 15 + 50 mm

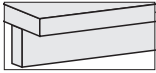

Blanc



CORIAN® - H 20 + 50 mm



173
Blanc



PIERRE - MARBRE - GRANITE - H 20 + 50 mm

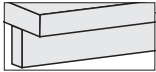

240
Marbre blanc
Carrara



250
Pierre Serena



257
Quartzite
Silver



199
Granite
Noir Absolu
Zimbabwe



261
Marbre
Emperador
Dark



254
Granite Black
Cosmic



259
Quartzite
Calacatta



260
Marbre Grey
Stone



273
Pietra d'Avola



274
Pierre Crema
d'Orcia



266
Marbre blanc
Carrara
Lithoverde®



265
Marbre Gris
du Marais
Lithoverde®



267
Pietra d'Avola
Lithoverde®

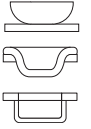

COMPOSITE DEKTON® - H 12 / 20 + 50 mm

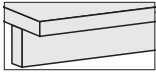

455
Beige Edora



453
Noir Sirius



454
Blanc Zenith



451
Gris Strato



459
Marron
Galema



461
Domoos



462
Keranium



460
Kelya

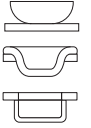
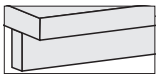

XILA BATH

Design C.R.S. Boffi

Modulares System aus Hänge-Unterschrank ohne Griffe. Die Fronten lassen sich mithilfe der schrägen Oberkante öffnen. Die spezifischen Waschtischplatten sind mit einer zurückgesetzten Frontblende versehen und vervollständigen das Badmöbel mit einem Griffleisteneffekt.

Waschtischplatte (1)

Rechteckige Waschtischplatte, mit unterer Frontblende in Ausführung, für Aufsatz-, Einbau- von oben, Unterbau- oder flächenbündiges formgepresstes Waschbecken.

STÄRKE: 12 - 15 - 20 mm (+ untere Frontblende H 50 mm)

TIEFE: 500 mm

KOMPATIBLE WASCHBECKEN: Aufsatz-, Einbau- von oben, Unterbau- und flächenbündige formgepresste Waschbecken (flächenbündige formgepresste Waschbecken in Cristalplant® nur aus Cristalplant®- flächenbündige formgepresste Waschbecken in Corian® nur aus Corian® - Unterbaubecken NICHT kompatibel mit Waschtischplatten in Lasermat).

AUSFÜHRUNGEN Stärke 12 mm (+ untere Blende H 50 mm): Agglomerat Dekton®.

AUSFÜHRUNGEN Stärke 15 mm (+ untere Blende H 50 mm): Cristalplant®.

AUSFÜHRUNGEN Stärke 20 mm (+ untere Blende H 50 mm): Corian®, Stein / Marmor / Granit / Agglomerat (Corian® kompatibel nur mit Aufsatzbecken in Ceramilux® oder flächenbündiges formgepresstes Waschbecken in Corian®).

Schubladen (2)

System LEGRABOX mit seitlichen und rückseitigen Blenden aus mattschwarz lackiertem Metall. Boden schwarze Melaminbeschichtung. Frontpaneel der Innenschubladen in melaminbeschichteter Ausführung wie Schrankelement.

Türen und Frontpaneele (3)

In Ausführung, Stärke 23 mm, mit oberer Abschrägung.

Schrank (4)

Aus Paneelen aus Spanplatte, Stärke 19 mm, wasserabweisend, mit geringem Formaldehydgehalt (zertifiziert Klasse E1, CARB P2 / TSCA Title VI), mit Melaminharzbeschichtung mit hoher Dichte. Vordere und rückseitige Kante aus ABS in Ausführung.

SEITENTEIL HÖHE: 300 - 470 mm (beide sind kompatibel mit Einbaubecken von oben / Unterbaubecken / flächenbündigen formgepressten Waschbecken Boffi).

HÖHE MIT FRONTPANEEL: 315 - 485 mm.

SEITENTEIL TIEFE: 470 mm.

TIEFE MIT FRONTPANEEL: 495 mm.

ELEMENTENBREITE: 300 - 450 - 600 - 900 - 1200 mm.

Abschlusspaneele (5)

In Ausführung, Stärke 23 mm (Stärke 20 mm für Stein / Marmor / Granit).

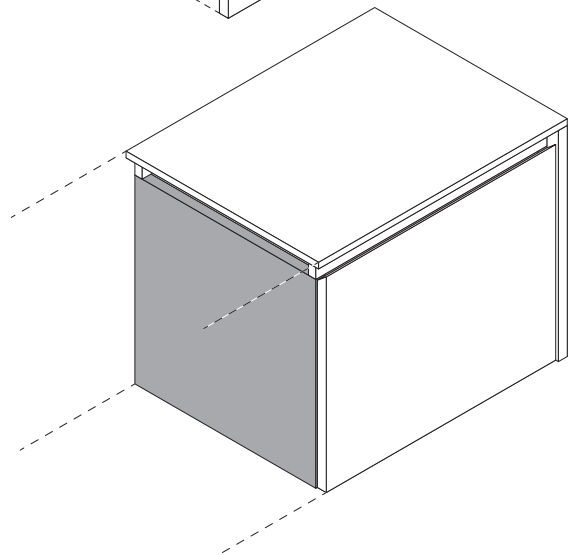
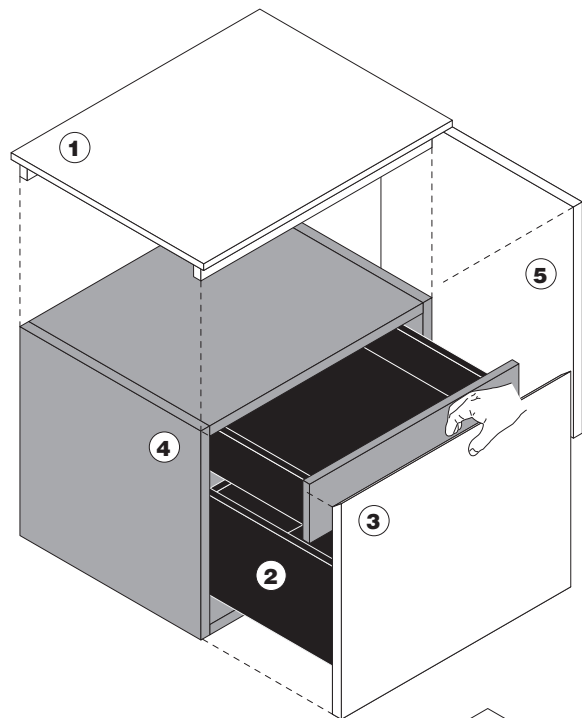

XILA BATH

ERHÄLTICHE AUSFÜHRUNGEN - ELEMENTE

MELAMINBESCHICHTETES
SCHRANKELEMENT



606
Ulme (Effect
offenporig)

610
Thermoholz
Lärche (Effect
offenporig)

608
Eiche
grafitgrau
(Effect
offenporig)

AUSFÜHRUNG
FRONTEN

FARBEN / HOLZARTEN

EASYLAK+

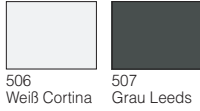

506
Weiß Cortina

507
Grau Leeds

ECOLAK



510
Arktischweiß

129
Magnolie

513
Wolkenfarben

024
Kieselgrau

512
Haferfarben

025
Ékrü

023
Lehm Braun

515
Basaltgrau

517
Kohlenschwarz

027
Schwarz

SILCOLAK

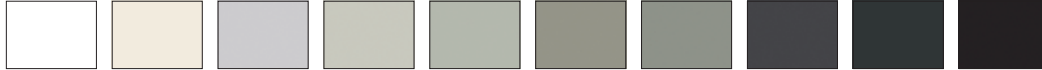

521
Weiß Sibirien

523
Perlweiß

524
Grau Luton

525
Grau Schotter

526
Heu

527
Naturfarben

528
Schlamm

529
Ardoise

530
Völlig schwarz

531
Tiefschwarz

HOLZ

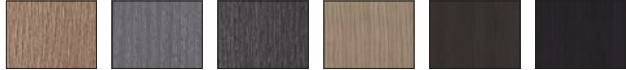
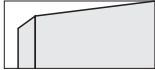

049
Eiche

033
Eiche
Aschgrau

076
Eiche
Grafitgrau

334
Ecowood Xilo
2.0 Planked
Sand (18.22)

335
Ecowood Xilo
2.0 Planked
Grey (18.23)

333
Ecowood Xilo
2.0 Striped
Black (18.04)

POLYESTER

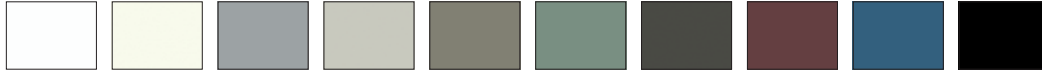
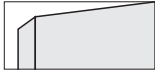

003
Weiß

129
Magnolie

005
Grau RAL
7038

024
Kieselgrau

063
Sandfarben

113
Grün caligo

004
Grau

107
Rot Petra

117
Blue Jodhpur

027
Schwarz

HOLZ SELECTION

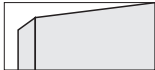

337
Amerikanische
Ulme

048
Kern-
Nussbaum

093
Nussbaum
Canaletto
U.S.

101
Räuchereiche

METALS

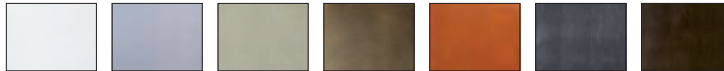
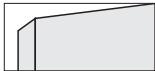

198
Weiß

934
Aluminium

197
Zink+

195
Messing
Vintage

196
Kupfer+

192
Titan

191
Blei

CORIAN®

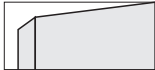

173
Weiß

MASSIVHOLZ



058
Nussbaum LIGHT Canaletto
Sägeschnitt

057
„Antikes“
Tannenholz
grau

066
Amerikanische
Ulme SW

067
Thermo-
Olivesche SW

102
Räuchereiche
gebeizt SW

HOLZ EXCLUSIVE



077
Abonos fossil
oak

XILA BATH

ERHÄLTICHE AUSFÜHRUNGEN - WASCHTISCHPLATTEN

WASCHBECKENARTEN



AUFSATZBECKEN



EINBAUBECKEN
von oben



UNTERBAUBECKEN



FLÄCHENBÜNDIG
formgepresst

AUSFÜHRUNG

WASCHTISCHPLATTEN

FARBEN / HOLZARTEN

WASCHBECKEN

CRISTALPLANT® - H 15 +50 mm



Weiß



CORIAN® - H 20 + 50 mm



173
Weiß



STEIN - MARMOR - GRANIT - H 20 + 50 mm



240
Carrara-
Marmor weiß



250
Stein Serena



257
Quarzit Silver



199
Granit
Tiefschwarz
Zimbabwe



261
Marmor
Emperador
Dark



254
Granit Black
Cosmic



259
Quarzit
Calacatta



260
Marmor Grey
Stone



273
Stein Pietra
D'Avola



274
Stein Crema
d'Orcia



266
Marmor
weiß Carrara
Lithoverde®



265
Marmor Gris
du Marais
Lithoverde®



267
Stein Pietra
D'Avola
Lithoverde®

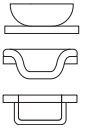

AGGLOMERAT DEKTON® - H 12 / 20 + 50 mm



455
Beige Edora



453
Schwarz
Sirius



454
Weiß Zenith



451
Grau Strato



459
Braun Galema



461
Domoos



462
Keranium



460
Kelya

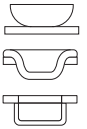

XILA BATH

Design C.R.S. Boffi

Sistema modular de muebles contenedores suspendidos sin tirador. La empuñadura (y apertura) de los frentes se produce gracias al chaflán presente en la parte superior. Las encimeras específicas, equipadas con banda frontal inferior atrasada en acabado, completan el mueble con efecto perfil tirador.

Encimera (1)

Encimera en ángulo recto con banda frontal inferior en acabado, que se puede equipar con lavabos sobre encimera apoyados, sobre encimera empotrados, bajo encimera empotrados y enrasados a la encimera moldeados.

GROSOR: 12 - 15 - 20 mm (+ banda frontal inferior H 50 mm)

PROFUNDIDAD: 500 mm

LAVABOS COMPATIBLES: sobre encimera apoyado, sobre encimera empotrado, bajo encimera empotrado y enrasado a la encimera moldeado (enrasado a la encimera moldeado de Cristalplant® sólo en encimeras de Cristalplant® - enrasado a la encimera moldeado de Corian® sólo en encimeras de Corian® - bajo encimera empotrado NO compatible con encimeras de Lasermat).

ACABADOS grosor 12 mm (+ banda frontal inferior H 50 mm): compuesto Dekton®.

ACABADOS grosor 15 mm (+ banda frontal inferior H 50 mm): Cristalplant®.

ACABADOS grosor 20 mm (+ banda frontal inferior H 50 mm): Corian®, piedra / mármol / granito / compuesto (Corian® compatible solo con lavabos sobre encimera de apoyo en Ceramilux® o enrasado al encimera moldeado en Corian®).

Cajones (2)

Sistema LEGRABOX, con laterales y trasera de metal pintado en color negro mate. Fondo de madera ennoblecida negra. Frente cajones internos en madera ennoblecida acabado mueble contenedor.

Puertas y frentes (3)

Realizadas en acabado, grosor 23 mm con chaflán superior.

Contenedor (4)

Realizados en paneles de partículas de madera grosor 19 mm, hidrófugos, con bajo contenido de formaldehído (certificado clase E1, CARB P2/ TSCA Title VI) melamínico con papeles con alto gramaje tratados con resinas melamínicas. Borde delantero y trasero en ABS del mismo color.

ALTURA COSTADO: 300 - 470 mm (ambas compatibles con lavabos Boffi sobre encimera empotrados / bajo encimera empotrados / enrasados a la encimera moldeados).

ALTURA CON FRENTE: 315 - 485 mm.

PROFUNDIDAD COSTADO: 470 mm.

PROFUNDIDAD CON FRENTE: 495 mm.

ANCHURA MÓDULO: 300 - 450 - 600 - 900 - 1200 mm.

Paneles terminales (5)

Realizados en acabado, grosor 23 mm (Grosor 20 mm para piedra / mármol / granito).

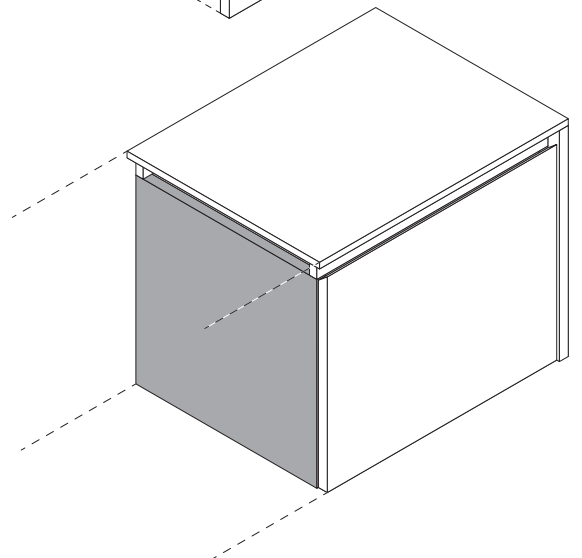
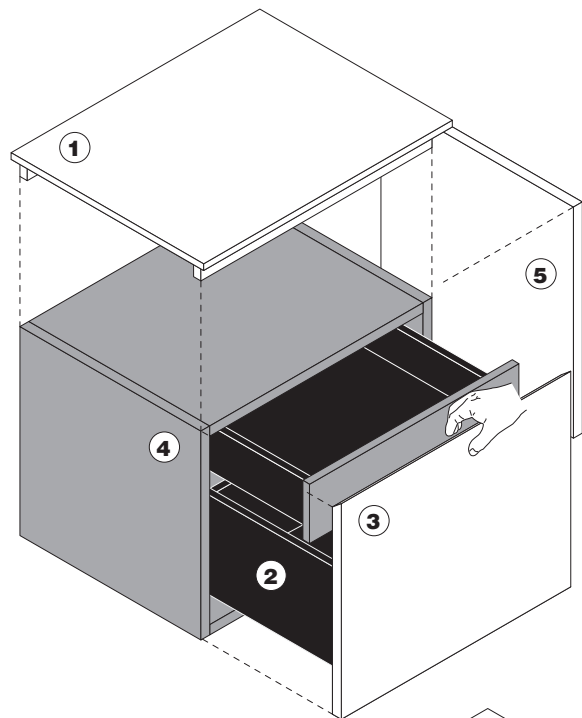



606 Olmo (efecto poro abierto)
610 Alerce térmico (efecto poro abierto)
608 Roble grafito (efecto poro abierto)

ACABADO
FRENTES

COLORES / MADERAS

EASYLAK+



506 Blanco Cortina
507 Gris Leeds

ECOLAK

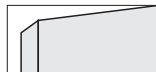

510 Blanco ártico
129 Magnolia
513 Nube
024 Guijarro
512 Avena
025 Crudo
023 Fango
515 Basalto
517 Carbón
027 Negro

SILCOLAK



521 Blanco Siberia
523 Ostra
524 Gris Luton
525 Grava
526 Heno
527 Cuerda
528 Limo
529 Pizarra
530 Negro Abismo
531 Negro Intenso

MADERA

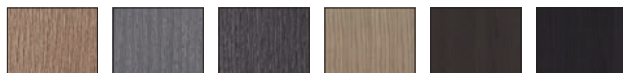

049 Roble
033 Roble ceniza
076 Roble grafito
334 Ecowood Xilo 2.0 Planked Sand (18.22)
335 Ecowood Xilo 2.0 Planked Grey (18.23)
333 Ecowood Xilo 2.0 Striped Black (18.04)

POLIÉSTER



003 Blanco
129 Magnolia
005 Gris RAL 7038
024 Guijarro
063 Arena
113 Verde caligo
004 Gris
107 Rojo Petra
117 Azul Jodhpur
027 Negro

MADERA SELECTION

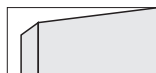

337 Olmo americano
048 Alma de nogal
093 Nogal canaletto (americano) U.S.
101 Roble ahumado

METALS

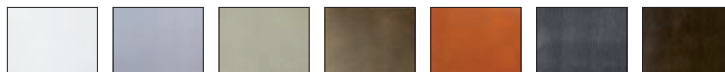
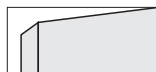

198 Blanco
934 Aluminium
197 Zink+
195 Latón Vintage
196 Cobre+
192 Titanio
191 Plomo

CORIAN®

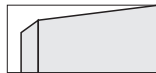

173 Blanco

MADERA MACIZA



058 Nogal LIGHT canaletto "corte sierra"
057 Abeto "antiguo" gris
066 Olmo americano SW
067 Fresno Olivato termtratado SW
102 Roble teñido ahumado SW

MADERA EXCLUSIVE



077 Abonos fossil oak

XILA BATH

ACABADOS REALIZABLES - ENCIMERAS

TIPOS LAVABOS



SOBRE
ENCIMERA
apoyado



SOBRE
ENCIMERA
empotrado



BAJO
ENCIMERA
empotrado



ENRASADO
A LA
ENCIMERA
moldeado

ACABADO
ENCIMERAS

COLORES / MADERAS

LAVABOS

CRISTALPLANT® - H 15 + 50 mm

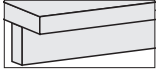

Blanco



CORIAN® - H 20 + 50 mm



173
Blanco



PIEDRA - MÁRMOL - GRANITO - H 20 + 50 mm



240
Mármol
blanco
Carrara



250
Piedra
Serena



257
Cuarcita
Silver



199
Granito Negro
Absoluto
Zimbabwe



261
Mármol
Emperador
Dark



254
Granito Black
Cosmic



259
Cuarcita
Calacatta



260
Mármol Grey
Stone



273
Pietra d'Avola



274
Piedra Crema
d'Orcia



266
Mármol blanco
Carrara
Lithoverde®



265
Mármol Gris
du Marais
Lithoverde®



267
Pietra d'Avola
Lithoverde®

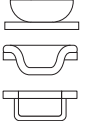

COMPUESTO DEKTON® - H 12 / 20 + 50 mm

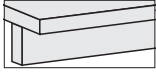

455
Beige Edora



453
Negro Sirius



454
Blanco Zenith



451
Gris Strato



459
Marrón
Galema



461
Domoos



462
Keranium



460
Kelya

