

CASE 5.0 BATH

Design Piero Lissoni

Sistema modulare di contenitori sospesi senza maniglia.
L'impugnatura (e l'apertura) dei frontali avviene grazie alla presenza della fascia maniglia montata sulla parte superiore del mobile.

Piano (1)

Piano squadrato allestibile con lavabi sopra piano da appoggio, sopra piano da incasso, sottopiano da incasso o filopiano stampato.

SPESSORE: 12 - 20 mm.

PROFONDITÀ PIANI: 527 mm.

Piano a sbalzo

Piano squadrato allestibile con lavabi sopra piano da appoggio.

Realizzato in CDF nero impiallacciato spessore 90 mm.

Copertura inferiore in CDF nero spessore 6 mm.

SPESSORE: 90 mm.

PROFONDITÀ PIANI: 527 mm.

Contenitore (2)

Realizzato in pannelli di particelle di legno di spessore 19 mm, idrofugo, a basso contenuto di formaldeide (certificato classe E1, CARB P2 / TSCA Title VI) nobilitato con carte ad alta grammatura trattate con resine melamminiche. Bordo anteriore e posteriore in ABS in tinta.

ALTEZZA FIANCO: 300 - 470 mm.

PROFONDITÀ FIANCO: 470 mm.

PROFONDITÀ CON FRONTALE: 522 mm.

LARGHEZZA MODULO: 300 - 450 - 600 - 900 - 1200 mm.

FINITURA: Nobilitato.

COLORI: Rovere grafite - Olmo - Larice termico.

Fascia maniglia (obbligatoria) (3)

In alluminio verniciato.

COLORE: bianco / nero.

Rivestimento per fascia maniglia (optional) (4)

Realizzato in finitura. Spessore variabile a seconda della finitura.

Incollata alla fascia maniglia in alluminio.

SPESSORE: max 20 mm.

Cassetti (5)

Sistema LEGRABOX, con spondine laterali e posteriore in metallo verniciato a polveri epossidiche. Fondo in nobilitato nero e frontale (cassetti interni) in nobilitato finitura contenitore. Tappetino interno antiscivolo realizzato in materiale atossico.

Frontali (6)

Spessore 50 mm (compresa impugnatura superiore spessore 8 mm) solo in versione estraibile

FINITURE: Silcolak - Ecolak - Legno - Easy Metals - Clay - Legno Selection - Poliestere - Corian® - Legno Exclusive - Vetro.

COLORI: Gamma completa colori/essenze.

Pannelli terminali (7)

Realizzati in finitura, spessore 50 mm.

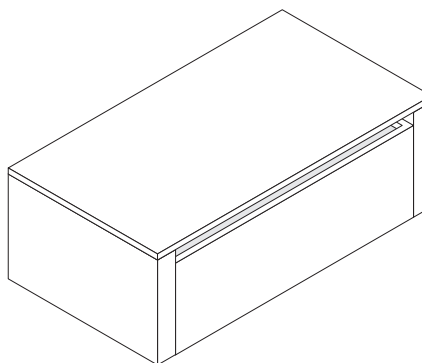
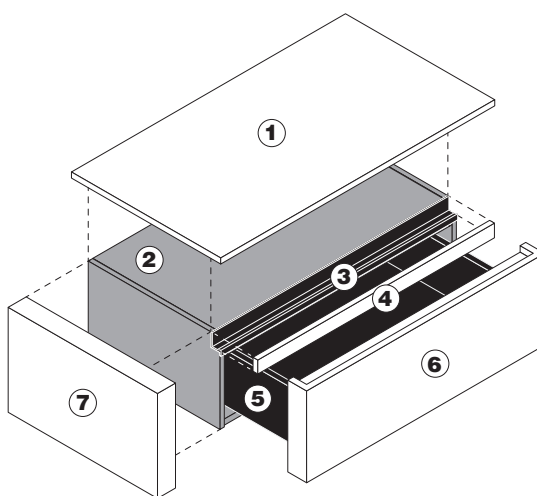
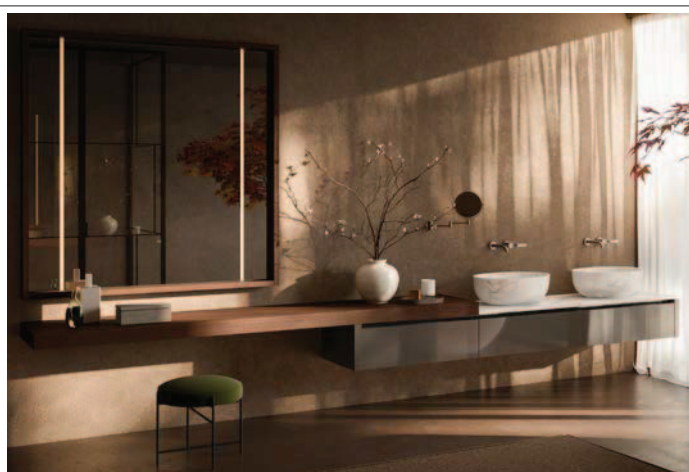

CASE 5.0 BATH

FINITURE REALIZZABILI - MOBILI

CONTENITORE
NOBILITATO

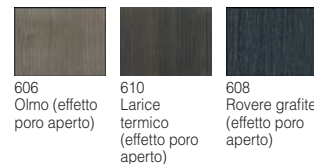

FINITURA
FRONTALI

COLORI / ESSENZE

SILCOLAK

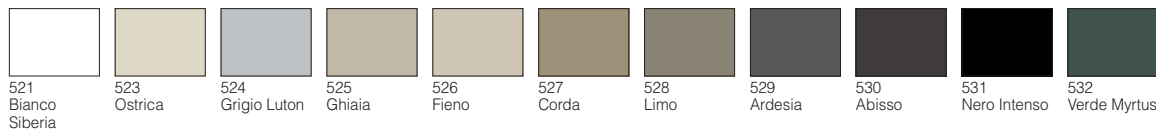

ECOLAK

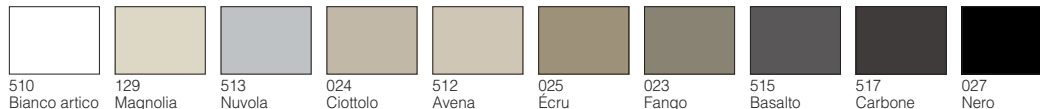

LEGNO

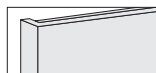

EASY METALS

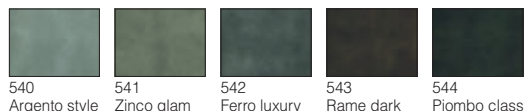

CLAY

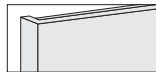

POLIESTERE

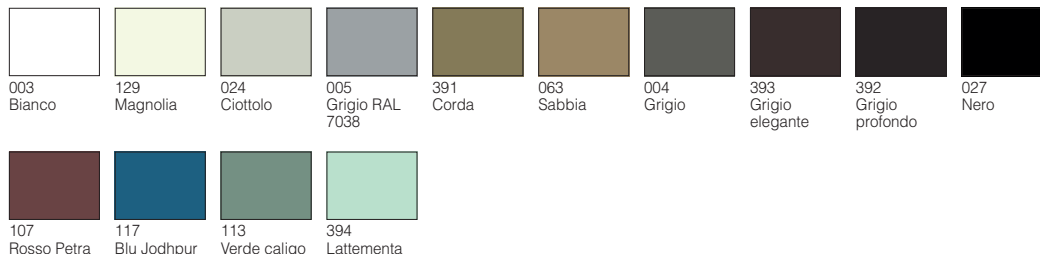
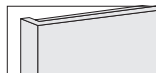

LEGNO SELECTION

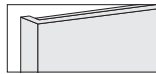

CORIAN®



LEGNO EXCLUSIVE

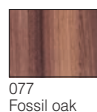

VETRO

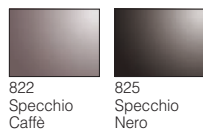
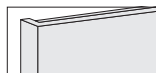

08/2023

it | en | fr | de | es

Boffi Spa - info@boffi.com - www.boffi.com

Boffi

CASE 5.0 BATH

FINITURE REALIZZABILI - PIANI

TIPOLOGIE LAVABI



FINITURA PIANI

COLORI / ESSENZE

LAVABI

CORIAN® - H 12 mm

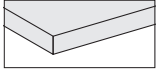

173
Bianco



CRISTALPLANT® - H 15 mm

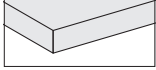

Bianco



LASERMAT - H 20 mm

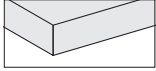

183
Bianco Kos



178
Bianco Malè



179
Beige Luxor



187
Beige Arizona



184
Grigio Efeso



202
Grigio Antrim



181
Grigio Londra



185
Grigio Bromo



186
Cacao
Orinoco



182
Nero Ingo



188
Verde
Comodoro



189
Rosso Jaipur



203
Blu Fes



CORIAN® - H 20 mm

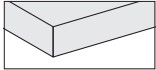

173
Bianco



PIETRA - MARMO - GRANITO - H 20 mm

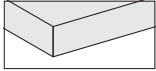

240
Marmo bianco
Carrara



299
Marmo Grigio
Italia



199
Granito Nero
Assoluto
Zimbabwe



261
Marmo
Emperador
Dark



254
Granito Black
Cosmic



260
Marmo Grey
Stone



278
Marmo Grigio
Carnico



259
Quarzite
Calacatta



279
Marmo bianco
Lasa Fior di
Melo



280
Marmo
Superwhite



300
Quarzite
Spider Black



COMPOSITO DEKTON® - H 20 mm

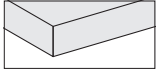

455
Beige Edora



453
Nero Sirius



464
Albarium



463
Argentum



465
Micron



461
Domoos



462
Keranium



454
Bianco Zenith



COMPOSITO MDI - H 12 mm

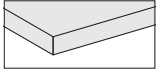

233
Bianco



234
Cammello



237
Grigio



238
Nero



282
Bihara



231
Devon



232
Surrey



281
Kanran



LEGNO MASSELLO - H 23 mm

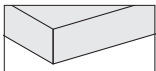

058
Noce LIGHT
canaletto
"taglio sega"



057
Abete "antico"
grigio



066
Olmo
americano
SW



067
Frassino olivato
termotreatato SW



102
Rovere tinto
affumicato
SW



CASE 5.0 BATH

Design Piero Lissoni

Wall hung, modular units without handle.

The doors are gripped (and opened) through the specific handle-rail, mounted on the upper part of the cabinet.

Top (1)

The square-edged top can be fitted with top-mounted, built-in, under-mounted or moulded flush-mounted washbasins.

THICKNESS: 12 - 20 mm

TOP DEPTH: 527 mm.

Protruding top

The square-edged top can be fitted with top-mounted washbasins.

In 90 mm thick veneer black CDF.

Lower covering panel in 6 mm thick black CDF.

THICKNESS: 90 mm

TOP DEPTH: 527 mm.

Unit (2)

It's made of 19 mm thick wood particle board panels, waterproof, with low formaldehyde emission (class E1, CARB P2 / TSCA Title VI certified), treated with high performance melamine resin. Front and back edges in ABS, same colour.

SIDE PANEL HEIGHT: 300 - 470 mm.

SIDE PANEL DEPTH: 470 mm.

DEPTH INCLUDING DOOR: 522 mm.

MODULE WIDTH: 300 - 450 - 600 - 900 - 1200 mm.

FINISH: Melamine.

COLOURS: grey-graphite oak - elm - thermo-treated larch wood.

Handle-rail (compulsory) (3)

In painted aluminium.

Colour: white / black.

Covering for handle-rail (optional) (4)

In finish. The thickness changes accordingly to finish.

Glued to the aluminium handle-rail.

THICKNESS: max 20 mm

Drawers (5)

LEGRABOX system with sides and back in epoxy-powder coated metal. Bottom in black melamine and front (of internal drawers) in melamine, same finish as carcass. Bottom is provided with non-toxic anti-slip mat.

Fronts (6)

50 mm thick (including 8 mm thick upper handle) - only in pull-out version.

FINISHES: Silcolak - Ecolak - Wood - Easy Metals - Clay - Wood Selection - Polyester - Corian® - Wood Exclusive - Glass.

COLOURS: full colours/wood species range.

End panels (7)

They are in finish, 50 mm. thick

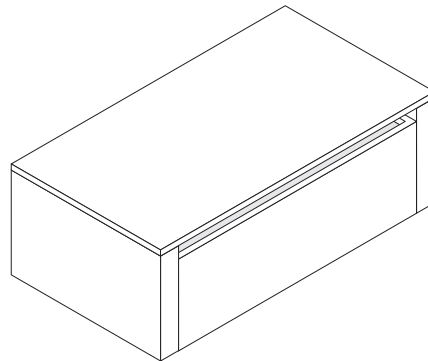
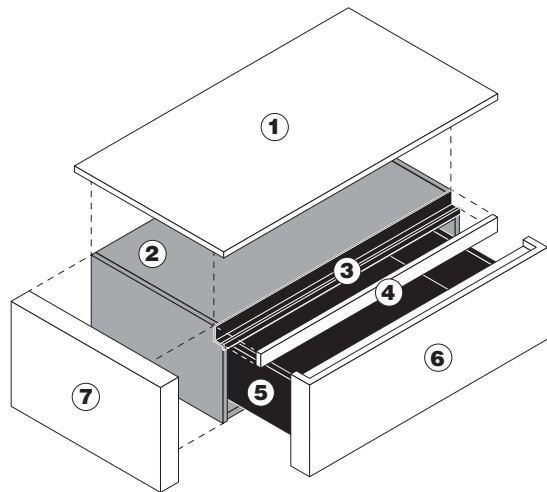

CASE 5.0 BATH

FEASIBLE FINISHES - CABINETS

MELAMINE-COATED
CARCASS

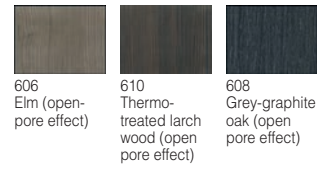

FRONTS FINISH

COLOURS / SPECIES

SILCOLAK



521
Siberia white



523
Oyster-pearl



524
Luton grey



525
Gravel grey



526
Hay



527
Rope-colour



528
Silt



529
Slate grey



530
Abyss black



531
Jet black



532
Myrtus green

ECOLAK



510
Arctic white



129
Magnolia



513
Cloud colour



024
Pebble grey



512
Oat colour



025
Ecrú



023
Mud



515
Basalt grey



517
Charcoal



027
Black

WOOD

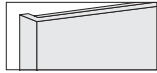

049
Oak



033
Ash-grey oak



076
Grey-graphite oak



334
Ecowood Xilo
2.0 Planked
Sand (18.22)



335
Ecowood Xilo
2.0 Planked
Grey (18.23)



333
Ecowood Xilo
2.0 Striped
Black (18.04)

EASY METALS

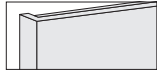

540
Silver style



541
Zinc Glam



542
Iron Luxury



543
Copper Dark



544
Lead Class

CLAY

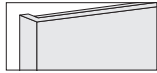

551
Hydra



555
Andromeda



552
Columbia



553
Pegaso



554
Lyra

POLYESTER

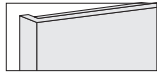

003
White



129
Magnolia



024
Pebble grey



005
Grey RAL
7038



391
Rope-colour



063
Sand



004
Grey



393
Elegant grey



392
Deep grey



027
Black



107
Petra red



117
Jodhpur blue



113
Caligo green



394
Milky mint

WOOD SELECTION

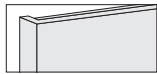

337
American elm



093
Canaletto
walnut U.S.



101
Smoked oak



346
Ecowood Indian
Rosewood
(10.23)



347
Ecowood
Datuk Ebony
(10.44)



348
Ecowood
Teak (10.74)



150
Alpine white
oak

CORIAN®

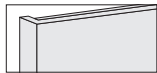

173
White

WOOD EXCLUSIVE

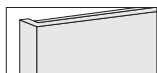

077
Fossil oak

GLASS



822
Mirror Coffee



825
Mirror Black

CASE 5.0 BATH

FEASIBLE FINISHES - TOPS

WASHBASIN
TYPOLOGIES



TOPS FINISH

COLOURS / SPECIES

WASHBASINS

CORIAN® - H 12 mm

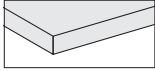

173
White



CRISTALPLANT® - H 15 mm

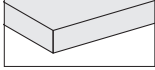

White



LASERMAT - H 20 mm

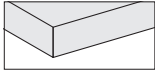

183
Kos white



178
Malè white



179
Luxor beige



187
Arizona beige



184
Efeso grey



202
Antrim grey



181
Londra grey



185
Bromo grey



186
Orinoco
cocoa



182
Ingo black



188
Comodoro
green



189
Jaipur red



203
Fes blue

CORIAN® - H 20 mm

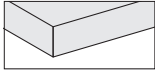

173
White



STONE - MARBLE - GRANITE - H 20 mm

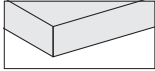

240
White Carrara
marble



299
Italia grey
marble



199
Absolute black
Zimbabwe
granite



261
Emperador
Dark marble



254
Black Cosmic
granite



260
Grey Stone
marble



278
Grey Carnico
marble



259
Quartzite
Calacatta



279
Apple
blossom white
Lasa marble



280
Superwhite
marble



300
Quartzite
Spider Black



DEKTON® COMPOSITE - H 20 mm

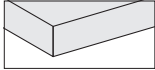

455
Edora beige



453
Sirius black



464
Albarium



463
Argentum



465
Micron



461
Domoos



462
Keranium



454
Zenith white



MDI COMPOSITE - H 12 mm

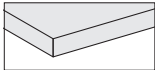

233
White



234
Camel



237
Grey



238
Black



282
Bihara



231
Devon



232
Surrey



281
Kanran



283
Camel cross



284
Camel points



285
Black cross



286
Black points

SOLID WOOD - H 23 mm

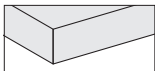

058
LIGHT Canaletto
walnut, "sawn"
effect



057
"Old" grey
pinewood



066
American elm
SW



067
Thermo-treated
Olivato ash
wood SW



102
Smoked dyed
oak SW



CASE 5.0 BATH

Design Piero Lissoni

Système modulaire d'éléments suspendus sans poignée.
La prise de main (et l'ouverture) des façades s'effectue grâce à la présence de la poignée-bandeau montée sur la partie supérieure du meuble.

Plan (1)

Plan avec chant droit aménageable avec lavabos sur plan d'appui, sur plan à encastrer, sous plan à encastrer ou affleurants moulés.
ÉPAISSEUR: 12 - 20 mm
PROFONDEUR PLANS: 527 mm.

Plan en saillie

Plan avec chant droit aménageable avec lavabos sur plan d'appui.
Réalisé en CDF noir peint épaisseur 90 mm.
Couverture inférieure en CDF noir épaisseur 6mm.
ÉPAISSEUR: 90 mm
PROFONDEUR PLANS: 527 mm.

Caisson (2)

Réalisé en panneaux de particules de bois d'épaisseur 19 mm, hydrofuge, à faible teneur en formaldéhyde (certifiée classe E1, CARB P2 / TSCA Title VI) mélaminé avec papiers à haute densité traités avec des résines mélaminiques. Chant avant et arrière en ABS de la même couleur.
HAUTEUR CÔTÉ: 300 - 470 mm.
PROFONDEUR CÔTÉ: 470 mm.
PROFONDEUR AVEC FAÇADE: 522 mm.
LARGEUR MODULE: 300 - 450 - 600 - 900 - 1200 mm.
FINITION: Mélaminé.
COULEURS: Chêne graphite - Orme - Mélèze thermique.

Poignée-bandeau (obligatoire) (3).

En aluminium peint.
COULEUR: blanc / noir.

Revêtement pour poignée-bandeau (optionnel) (4)

Réalisées selon les finitions disponibles. Épaisseur variable selon la finition.
Collée à la poignée-bandeau en aluminium.
ÉPAISSEUR: max 20 mm.

Tiroirs (5)

Système LEGRABOX, avec rebords latéraux et arrière en métal peint à poudres epoxy. Panneau de fond en mélaminé noir et façade (tiroirs internes) en mélaminé finition caisson. Petit tapis interne antidérapant en matériau atoxique.

Façades (6)

Épaisseur 50 mm (y compris la prise de main supérieure épaisseur 8 mm) uniquement en version extractible
FINITIONS: Silcolak - Ecolak - Bois - Easy Metals - Clay - Bois Selection - Polyester - Corian® - Bois Exclusive - Verre.
COULEURS: Gamme complète couleurs/essences.

Panneaux d'extrémité (7)

Réalisés selon les finitions disponibles, épaisseur 50 mm.

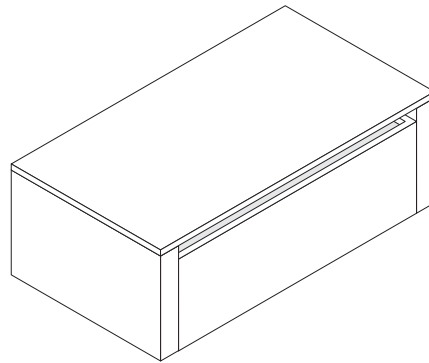
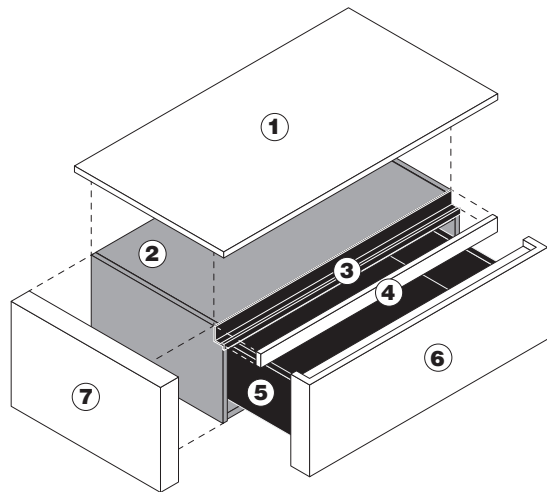

CASE 5.0 BATH

FINITIONS RÉALISABLES - MEUBLES

CAISSONS EN
MÉLAMINÉ



606
Orme (effet
pores
ouverts)

610
Mélèze
thermique
(effet pores
ouverts)

608
Chêne
graphite
(effet pores
ouverts)

FINITION FAÇADES COULEURS / ESSENCES

SILCOLAK

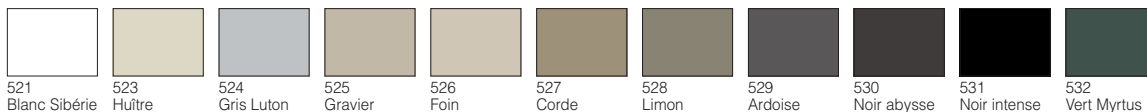

521
Blanc Sibérie

523
Huître

524
Gris Luton

525
Gravier

526
Foin

527
Corde

528
Limon

529
Ardoise

530
Noir abysse

531
Noir intense

532
Vert Myrtus

ECOLAK

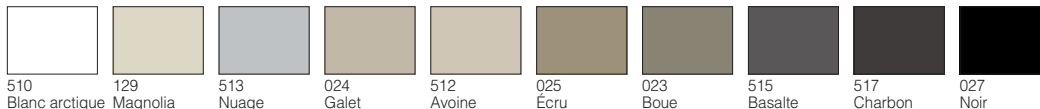

510
Blanc arctique

129
Magnolia

513
Nuage

024
Galet

512
Avoine

025
Ecrû

023
Boue

515
Basalte

517
Charbon

027
Noir

BOIS

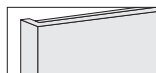

049
Chêne

033
Chêne cendré
gris

076
Chêne
graphite

334
Ecowood Xilo
2.0 Planked
Sand (18.22)

335
Ecowood Xilo
2.0 Planked
Grey (18.23)

333
Ecowood Xilo
2.0 Striped
Black (18.04)

EASY METALS

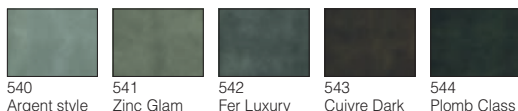

540
Argent style

541
Zinc Glam

542
Fer Luxury

543
Cuivre Dark

544
Plomb Class

CLAY

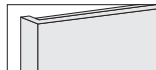

551
H 418 mm

555
Andromeda

552
Columbia

553
Pegaso

554
Lyra

POLYESTER

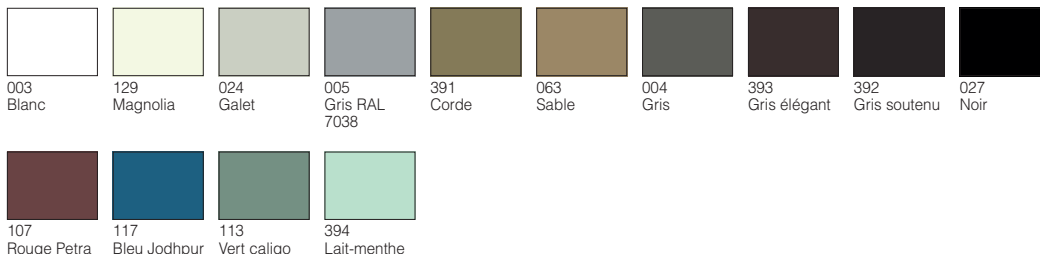

003
Blanc

129
Magnolia

024
Galet

005
Gris RAL
7038

391
Corde

063
Sable

004
Gris

393
Gris élégant

392
Gris soutenu

027
Noir

107
Rouge Petra

117
Bleu Jodhpur

113
Vert caligo

394
Lait-menthe

BOIS SELECTION

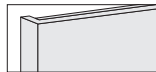

337
Orme
Américain

093
Noyer
"canaletto"
U.S.

101
Chêne fumé

346
Ecowood Indian
Rosewood
(10.23)

347
Ecowood
Datuk Ebony
(10.44)

348
Ecowood
Teak (10.74)

150
Chêne blanc
alpin

CORIAN®



173
Blanc

BOIS EXCLUSIVE

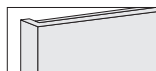

077
Fossil oak

VERRE



822
Miroir Café

825
Miroir Noir

CASE 5.0 BATH

FINITIONS RÉALISABLES - PLANS

TYPOLOGIES LAVABOS



SUR PLAN
d'appui



SUR PLAN à
encastrer



SOUS PLAN
à encastrer



AFFLEURANT
moulé

FINITION PLANS

COULEURS / ESSENCES

LAVABOS

CORIAN® - H 12 mm

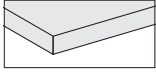

173
Blanc



CRISTALPLANT® - H 15 mm

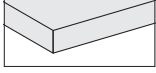

Blanc



LASERMAT - H 20 mm

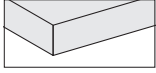

183
Blanc Kos



178
Blanc Malè



179
Beige Luxor



187
Beige Arizona



184
Gris Efeso



202
Gris Antrim



181
Gris Londra



185
Gris Bromo



186
Cacao
Orinoco



182
Noir Ingo



188
Vert
Comodoro



189
Rouge Jaipur



203
Bleu Fes



CORIAN® - H 20 mm

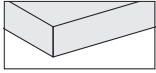

173
Blanc



PIERRE - MARBRE - GRANITE - H 20 mm

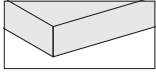

240
Marbre blanc
Carrara



299
Marbre Gris
Italia



199
Granite
Noir Absolu
Zimbabwe



261
Marbre
Emperador
Dark



254
Granite Black
Cosmic



260
Marbre Grey
Stone



278
Marbre Gris
Carnico



259
Quartzite
Calacatta



279
Marbre blanc
Lasa Fleur de
Pommier



280
Marbre
Superwhite



300
Quartzite
Spider Black



COMPOSITE DEKTON® - H 20 mm

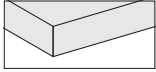

455
Beige Edora



453
Noir Sirius



464
Albarium



463
Argentum



465
Micron



461
Domoos



462
Keranium



454
Blanc Zenith



COMPOSITE MDI - H 12 mm

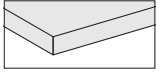

233
Blanc



234
Chameau



237
Gris



238
Noir



282
Bihara



231
Devon



232
Surrey



281
Kanran



283
Chameau
cross



284
Chameau
points



285
Noir cross



286
Noir points

BOIS MASSIF - H 23 mm

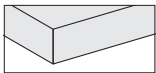

058
Noyer LIGHT
canaletto
"effet scié"



057
Sapin
"antique" gris



066
Orme
Américain SW



067
Frêne olivier
thermotraité SW



102
Chêne teinté
fumé SW



CASE 5.0 BATH

Design Piero Lissoni

Anbausystem mit Hänge-Schränkelementen ohne Griffe.
Die Fronten lassen sich mithilfe der Griffleiste auf Oberkante des Schrankes öffnen.

Waschtischplatte (1)

Rechteckige Waschtischplatte für Aufsatz-, Einbau- von oben, Unterbau-oder flächenbündiges formgepresstes Waschbecken.
STÄRKE: 12 - 20 mm
WASCHTISCHPLATTE TIEFE: 527 mm.

Waschtischplatte mit Überhang

Rechteckige Waschtischplatte, die mit Aufsatzbecken ausgestattet werden kann.
Aus schwarzem CDF furniert, St. 90 mm.
Untere Abdeckung aus schwarzem CDF, 6 mm stark.
STÄRKE: 90 mm.
WASCHTISCHPLATTE TIEFE: 527 mm.

Schrank (2)

Aus Spanplatte, Stärke 19 mm, wasserabweisend, mit niedrigem Formaldehydgehalt (zertifiziert Klasse E1, CARB P2 / TSCA Title VI) mit Melaminharzbeschichtung mit hoher Dichte. Vordere und hintere Kante aus ABS, gleiche Farbe.
SEITENTEIL HÖHE: 300 - 470 mm.
SEITENTEIL TIEFE: 470 mm.
TIEFE MIT FRONT: 522 mm.
MODULBREITE: 300 - 450 - 600 - 900 - 1200 mm.
AUSFÜHRUNG: Melaminharzbeschichtung.
FARBEN: Eiche Grafitgrau - Ulme - Thermolärche.

Griffleiste (zwingend erforderlich) (3)

Aus Aluminium lackiert.
FARBE: weiß / schwarz.

Verkleidung für Griffleiste (optional) (4)

In Ausführung. Stärke abhängig vor Ausführung.
Verklebt auf Griffleiste in Aluminium
STÄRKE: max. 20 mm.

Schubladen (5)

System LEGRABOX mit rückseitigen und seitlichen Blenden aus epoxidpulverlackiertem Metall. Boden mit Melaminharzbeschichtung schwarz und Front (Innenschubladen) mit Melaminharzbeschichtung Ausführung Schrankelement. Antirutschmatte aus ungiftigem Material.

Fronten (6)

Stärke 50 mm (einschließlich 8 mm starkem oberen Handgriff) - nur in ausziehbarer Version.
AUSFÜHRUNGEN: Silcolak - Ecolak - Holz - Easy Metals - Clay - Holz Selection - Polyester - Corian® - Holz Exclusive - Glas.
FARBEN: Vollständige Auswahl Farben/Holzarten.

Abschlusspaneele (7)

In Ausführung, Stärke 50 mm

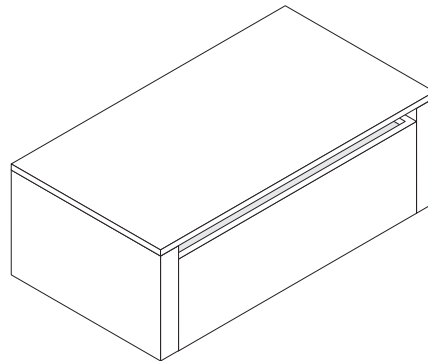
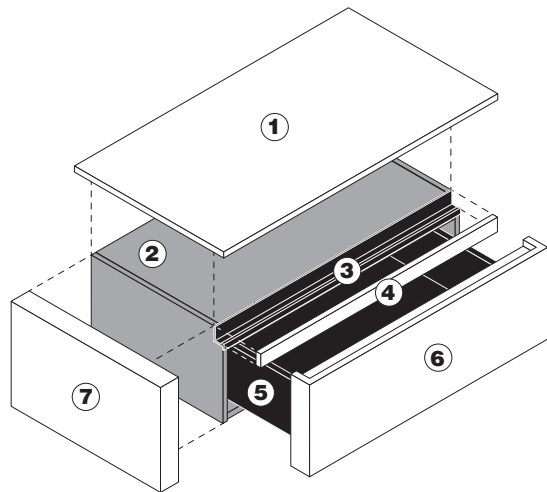

CASE 5.0 BATH

ERHÄLTICHE AUSFÜHRUNGEN - SCHRÄNKE

MELAMINBESCHICHTETES KORPUS



606
Ulme (Effekt
offenporig)

610
Thermoholz
Lärche (Effekt
offenporig)

608
Eiche
grafitgrau
(Effekt
offenporig)

AUSFÜHRUNG FRONTEN

FARBEN / HOLZARTEN

SILCOLAK

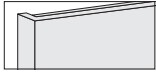

521
Weiß Sibirien



523
Perlweiß



524
Grau Luton



525
Grau Schotter



526
Heu



527
Naturfarben



528
Schlamm



529
Ardoise



530
Völlig schwarz



531
Tiefschwarz



532
Grün Myrtus

ECOLAK



510
Arktischweiß



129
Magnolie



513
Wolkenfarben



024
Kieselgrau



512
Haferfarben



025
Ekrü



023
Lehm Braun



515
Basaltgrau



517
Kohlschwarz



027
Schwarz

HOLZ



049
Eiche



033
Eiche
Aschgrau



076
Eiche
Grafitgrau



334
Ecowood Xilo
2.0 Planked
Sand (18.22)



335
Ecowood Xilo
2.0 Planked
Grey (18.23)



333
Ecowood Xilo
2.0 Striped
Black (18.04)

EASY METALS

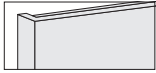

540
Silber style



541
Zink Glam



542
Eisen Luxury



543
Kupfer Dark



544
Blei Class

CLAY

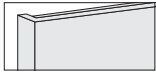

551
Hydra



555
Andromeda



552
Columbia



553
Pegaso



554
Lyra

POLYESTER

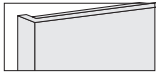

003
Weiß



129
Magnolie



024
Kieselgrau



005
Grau RAL
7038



391
Naturfarben



063
Sandfarben



004
Grau



393
Elegantes
grau



392
Tiefes grau



027
Schwarz



107
Rot Petra



117
Blau Jodhpur



113
Grün caligo



394
Milch Minze

HOLZ SELECTION

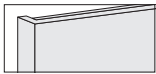

337
Amerikanische
Ulme



093
Nussbaum
Canaletto
U.S.



101
Räuchereiche



346
Ecowood Indian
Rosewood
(10.23)



347
Ecowood
Datuk Ebony
(10.44)



348
Ecowood
Teak (10.74)



150
Eiche Alpin
weiß

CORIAN®

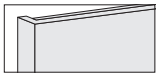

173
Weiß

HOLZ EXCLUSIVE

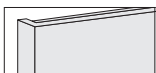

077
Fossil oak

GLAS



822
Spiegel
Kaffee



825
Schwarzer
Spiegel

CASE 5.0 BATH

ERHÄLTICHE AUSFÜHRUNGEN - WASCHTISCHPLATTEN

WASCHBECKENARTEN



AUSFÜHRUNG

WASCHTISCHPLATTEN FARBEN / HOLZARTEN

WASCHBECKEN

CORIAN® - H 12 mm

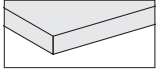

173
Weiß



CRISTALPLANT® - H 15 mm

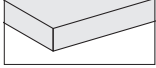

Weiß



LASERMAT - H 20 mm

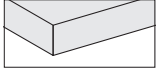

183
Weiß Kos



178
Weiß Kos



179
Beige Luxor



187
Beige Arizona



184
Grau Efeso



202
Grau Antrim



181
Grau Londra



185
Grau Bromo



186
Kakao
Orinoco



182
Schwarz Ingo



188
Grün
Comodoro



189
Rot Jaipur



203
Blau Fes



CORIAN® - H 20 mm

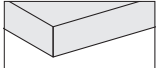

173
Weiß



STEIN - MARMOR - GRANIT - H 20 mm

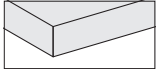

240
Marmor
Carrara weiß



299
Marmor Grau
Italia



199
Granit
Tiefschwarz
Zimbabwe



261
Marmor
Emperador
Dark



254
Granit Black
Cosmic



260
Marmor Grey
Stone



278
Marmor Grau
Carnico



259
Quarzit
Calacatta



279
Apfelbaumblüten-
Weiß Laaser
Marmor



280
Marmor
Superwhite



300
Quarzit Spider
Black



VERBUNDMATERIAL DEKTON® - H 20 mm

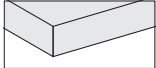

455
Beige Edora



453
Schwarz
Sirius



464
Albarium



463
Argentium



465
Micron



461
Domoos



462
Keranium



454
Weiß Zenith



VERBUNDMATERIAL MDI - H 12 mm

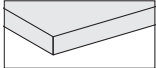

233
Weiß



234
Kamel



237
Grau



238
Schwarz



282
Bihara



231
Devon



232
Surrey



281
Kanran



283
Kamel cross



284
Kamel points



285
Schwarz
cross



286
Schwarz
points

MASSIVHOLZ - H 23 mm

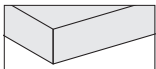

058
Nussbaum-LIGHT
Canaletto
Sägeschnitt



057
„Antikes“
Tannenholz
grau



066
Amerikanische
Ulme SW



067
Thermo-
Olivesche SW



102
Räuchereiche
gebeizt SW



CASE 5.0 BATH

Design Piero Lissoni

Sistema modular de muebles contenedores suspendidos sin tirador. La empuñadura (y la apertura) de los frentes se produce gracias a la presencia del perfil tirador montado en la parte superior del mueble.

Encimera (1)

Encimera en ángulo recto que se puede equipar con lavabos sobre encimera apoyados, sobre encimera empotrados, bajo encimera empotrados y enrasados a la encimera moldeados.

GROSOR: 10 12 - 20 mm

PROFUNDIDAD ENCIMERAS: 527 mm.

Encimeras salientes

Encimera en ángulo recto que se pueden equipar con lavabos sobre encimera apoyados.

Realizado en CDF negro chapado de 90 mm de grosor.

Cubierta inferior en CDF negro de 6 mm de grosor.

GROSOR: 90 mm.

PROFUNDIDAD ENCIMERAS: 527 mm.

Contenedor (2)

Realizado con paneles de partículas de madera de 19 mm. de grosor hidrófugo, de bajo contenido de formaldehído (certificado clase E1, CARB P2 / TSCA Title VI) madera ennoblecida con papeles de alto gramaje tratados con resinas de melamina. Borde delantero y trasero de ABS del mismo color.

ALTURA COSTADO: 300 - 470 mm.

PROFUNDIDAD COSTADO: 470 mm.

PROFUNDIDAD CON FRENTE: 522 mm.

ANCHURA MÓDULO: 300 - 450 - 600 - 900 - 1200 mm.

ACABADO: Madera ennoblecida.

COLORES: Roble grafito - Olmo - Alerce térmico.

Perfil tirador (obligatorio) (3)

De aluminio pintado.

COLOR: blanco / negro.

Revestimiento para perfil tirador (optional) (4)

Realizado en acabado. Grosor variable dependiendo del acabado.

Encolada al perfil tirador de aluminio.

GROSOR: máx 20 mm.

Cajones (5)

Sistema LEGRABOX, con laterales y trasera de metal pintado con polvos epoxídicos. Fondo de madera ennoblecida negra y frontal (cajones internos) de madera ennoblecida acabado mueble contenedor. Tapete interno antideslizante realizado en material no tóxico.

Frentes (6)

Grosor 50 mm (incluida empuñadura superior de 8 mm de grosor) solo en versión extraíble

ACABADOS: Silcolak - Ecolak - Madera - Easy Metals - Clay - Madera Selection - Poliéster - Corian® - Madera Exclusive - Vidrio.

COLORES: Gama completa colores/maderas.

Paneles terminales (7)

Realizados en acabado, 50 mm de grosor.

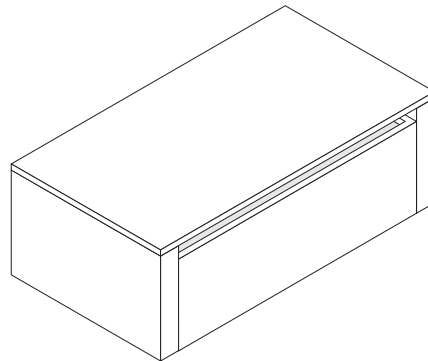
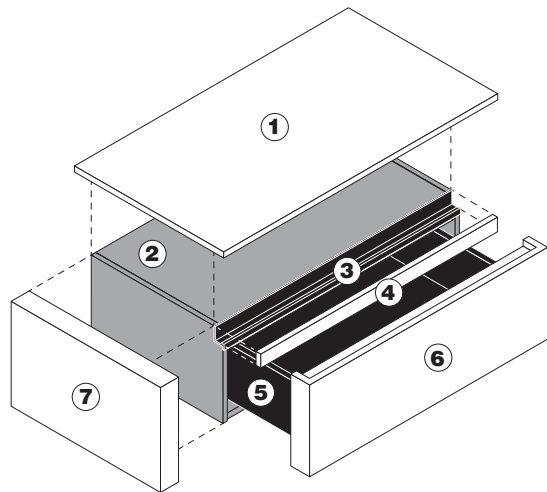

CASE 5.0 BATH

ACABADOS REALIZABLES - MUEBLES

MUEBLES
CONTENEDORES
DE MADERA
ENNOBLECIDA



606
Olm (efecto
poro abierto)

610
Alerce
térnico
(efecto poro
abierto)

608
Roble grafito
(efecto poro
abierto)

ACABADO
FRENTE

COLORES / MADERAS

SILCOLAK

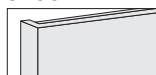

521
Blanco
Siberia



523
Ostra



524
Gris Luton



525
Grava



526
Heno



527
Cuerda



528
Limo



529
Pizzarra



530
Negro Abismo



531
Negro Intenso



532
Verde Myrtus

ECOLAK



510
Blanco ártico



129
Magnolia



513
Nube



024
Guijarro



512
Avena



025
Crudo



023
Fango



515
Basalto



517
Carbón



027
Negro

MADERA

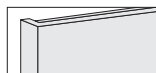

049
Roble



033
Roble ceniza



076
Roble grafito



334
Ecowood Xilo
2.0 Planked
Sand (18.22)



335
Ecowood Xilo
2.0 Planked
Grey (18.23)



333
Ecowood Xilo
2.0 Striped
Black (18.04)

EASY METALS



540
Plata style



541
Zinc Glam



542
Hierro Luxury



543
Cobre Dark



544
Plomo Class

CLAY



551
H 418 mm



555
Andromeda



552
Columbia



553
Pegaso



554
Lyra

POLIÉSTER

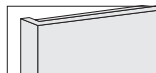

003
Blanco



129
Magnolia



024
Guijarro



005
Gris RAL
7038



391
Cuerda



063
Arena



004
Gris



393
Gris elegante



392
Gris profundo



027
Negro



107
Rojo Petra



117
Azul Jodhpur



113
Verde caligo



394
Lechenta

MADERA SELECTION

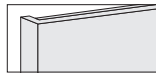

337
Olm
americano



093
Nogal canaletto
(americano)
U.S.



101
Roble
ahumado



346
Ecowood Indian
Rosewood
(10.23)



347
Ecowood
Datuk Ebony
(10.44)



348
Ecowood
Teak (10.74)



150
Roble blanco
alpino

CORIAN®

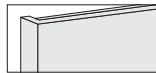

173
Blanco

MADERA EXCLUSIVE



077
Fossil oak

VIDRIO

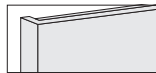

822
Espejo Café



825
Espejo Negro

CASE 5.0 BATH

ACABADOS REALIZABLES - ENCIMERAS

TIPOS LAVABOS



SOBRE
ENCIMERA
apoyado



SOBRE
ENCIMERA
empotrado



BAJO
ENCIMERA
empotrado



ENRASADO
A LA
ENCIMERA
moldeado

ACABADO
ENCIMERAS

COLORES / MADERAS

LAVABOS

CORIAN® - H 12 mm

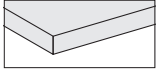

173
Blanco



CRISTALPLANT® - H 15 mm

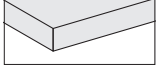

Blanco



LASERMAT - H 20 mm

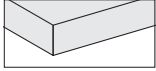

183
Blanco Kos



178
Blanco Malè



179
Beige Luxor



187
Beige Arizona



184
Gris Efeso



202
Gris Antrim



181
Gris Londra



185
Gris Bromo



186
Cacao
Orinoco



182
Negro Ingo



188
Verde
Comodoro



189
Rojo Jaipur



203
Azul Fes



CORIAN® - H 20 mm

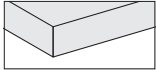

173
Blanco



PIEDRA - MÁRMOL - GRANITO - H 20 mm

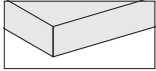

240
Mármol
blanco
Carrara



299
Mármol Gris
Italia



199
Granito Negro
Absoluto
Zimbabwe



261
Mármol
Emperador
Dark



254
Granito Black
Cosmic



260
Mármol Grey
Stone



278
Mármol Gris
de Carnia



259
Cuarcita
Calacatta



279
Mármol blanco
Lasa Flor de
Manzano



280
Mármol
Superwhite



300
Cuarcita
Spider Black



COMPUESTO DEKTON® - H 20 mm

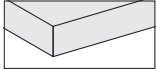

455
Beige Edora



453
Negro Sirius



464
Albarium



463
Argentium



465
Micron



461
Domoos



462
Keranium



454
Blanco Zenith



COMPUESTO MDI - H 12 mm

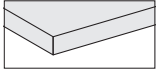

233
Blanco



234
Camello



237
Gris



238
Negro



282
Bihara



231
Devon



232
Surrey



281
Kanran



283
Camello cross



284
Camello point



285
Negro cross



286
Negro points

MADERA MACIZA - H 23 mm

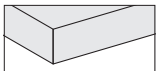

058
Nogal LIGHT
canaletto
"corte sierra"



057
Abeto
"antiguo" gris



066
Olmo
americano
SW



067
Fresno Olivato
termotratado SW



102
Roble teñido
ahumado SW

