

Programma STANDARD

Design Piero Lissoni + C.R.S. Boffi

Sistema modulare di contenitori base / colonna sospesi. Maniglia obbligatoria.

Piano (1)

Piano squadrato allestibile con lavabi sopra piano da appoggio, sopra piano da incasso, sottopiano da incasso o filopiano stampato.

SPESORE: 12 - 15 - 20 - 23 mm.

PROFONDITÀ: 500 mm.

Contenitore (2)

Realizzato in pannelli di particelle di legno di spessore 19 mm, idrofughi, a basso contenuto di formaldeide (certificato classe E1, CARB P2 / TSCA Title VI) nobilitato con carte ad alta grammatura trattate con resine melamminiche. Bordo anteriore e posteriore in ABS in tinta.

ALTEZZA FIANCO: 300 - 470 mm (entrambe compatibili con incasso di lavabi Boffi sopra piano da incasso / sottopiano da incasso / filopiano stampato).

PROFONDITÀ FIANCO: 470 mm.

PROFONDITÀ CON FRONTALE: 495 mm.

LARGHEZZA MODULO: 300 - 450 - 600 - 900 - 1200 mm.

Fianco in finitura (3)

Su ogni composizione vengono realizzati, senza sovrapprezzo, i fianchi esterni terminali in finitura (considerare che per i mobili con frontali in Corian® il fianco finito sarà in Ecolak bianco / per mobili con frontali in Legno 3D il fianco sarà in impiallacciato liscio, senza effetto-listoni).

Il fianco in finitura comprende anche la finitura del bordo verticale a vista (escluso Lasermat).

Il fianco in finitura NON è realizzabile in LEGNO MASSELLO e LEGNO MASSELLO 3D: per queste finiture è necessario ordinare separatamente i pannelli terminali.

Cassetti (4)

Sistema LEGRABOX, con spondine laterali e posteriore in metallo verniciato in colore nero opaco. Fondo in nobilitato nero. Frontale cassetti interni in nobilitato finitura contenitore.

Ante e frontali (5)

Realizzate in finitura, spessore 23 mm, maniglia obbligatoria.

Maniglia (6)

Ogni frontale deve essere provvisto di maniglia, a scelta tra quelle di gamma, senza o con maggiorazione di prezzo.

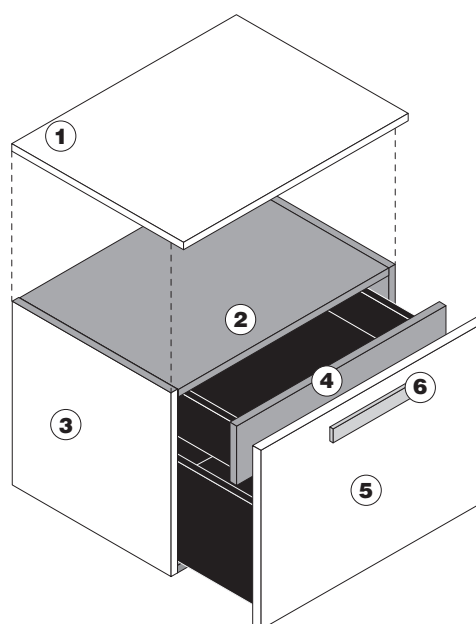

Programma STANDARD

FINITURE REALIZZABILI - MOBILI

CONTENITORE
NOBILITATO

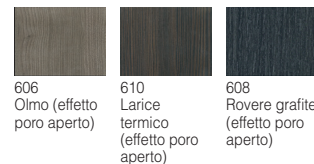

FINITURA
FRONTALI

COLORI / ESSENZE

EASYLAK+

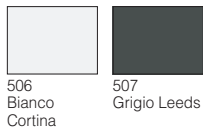

506 Bianco Cortina
507 Grigio Leeds

LASERMAT

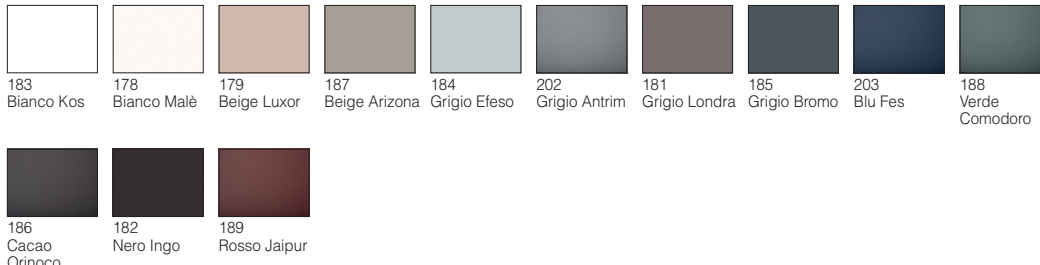

183 Bianco Kos
178 Bianco Malè
179 Beige Luxor
187 Beige Arizona
184 Grigio Efeso
202 Grigio Antrim
181 Grigio Londra
185 Grigio Bromo
203 Blu Fes
188 Verde Comodoro
186 Cacao Orinoco
182 Nero Ingo
189 Rosso Jaipur

SILCOLAK

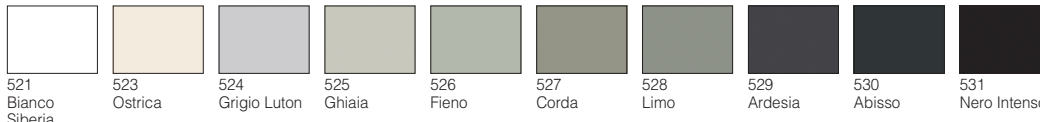

521 Bianco Siberia
523 Ostrica
524 Grigio Luton
525 Ghiaia
526 Fieno
527 Corda
528 Limo
529 Ardesia
530 Abisso
531 Nero Intenso

ECOLAK

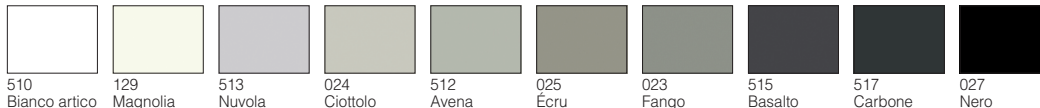
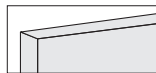

510 Bianco artico
129 Magnolia
513 Nuvola
024 Ciottolo
512 Avena
025 Ecrù
023 Fango
515 Basalto
517 Carbone
027 Nero

LEGNO

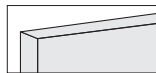

049 Rovere
033 Rovere cenere
076 Rovere grafite
334 Ecowood Xilo 2.0 Planked Sand (18.22)
335 Ecowood Xilo 2.0 Planked Grey (18.23)
333 Ecowood Xilo 2.0 Striped Black (18.04)

POLIESTERE

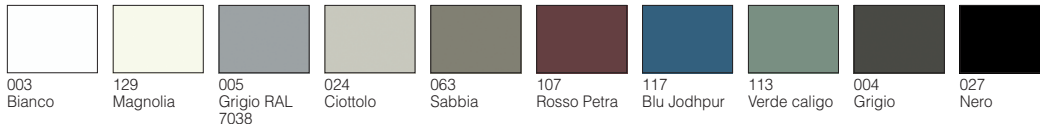
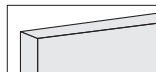

003 Bianco
129 Magnolia
005 Grigio RAL 7038
024 Ciottolo
063 Sabbia
107 Rosso Petra
117 Blu Jodhpur
113 Verde caligo
004 Grigio
027 Nero

LEGNO SELECTION

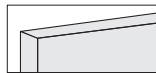

337 Olmo americano
048 Noce colore
093 Noce canaletto U.S.
101 Rovere affumicato

METALS



198 Bianco
934 Aluminium
197 Zinco+
195 Ottone Vintage
196 Rame+
192 Titanio
191 Piombo

CORIAN®



173 Bianco

Programma STANDARD

FINITURE REALIZZABILI - MOBILI

CONTENITORE
NOBILITATO



606
Olmo (effetto
poro aperto)

610
Larice
termico
(effetto poro
aperto)

608
Rovere grafite
(effetto poro
aperto)

FINITURA
FRONTALI

COLORI / ESSENZE

LEGNO 3D

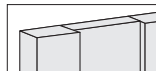

049
Rovere



033
Rovere
cenere



076
Rovere grafite



337
Olmo
americano



048
Noce colore



334
Ecowood Xilo
2.0 Planked
Sand (18.22)



335
Ecowood Xilo
2.0 Planked
Grey (18.23)



333
Ecowood Xilo
2.0 Striped
Black (18.04)



093
Noce
canaletto U.S.



101
Rovere
affumicato

LEGNO MASSELLO



058
Noce LIGHT
canaletto
"taglio sega"



057
Abete "antico"
grigio



066
Olmo
americano
SW



067
Frassino olivato
termotrattato SW



102
Rovere tinto
affumicato
SW

LEGNO MASSELLO 3D (Prezzo: LEGNO MASSELLO + 10%)

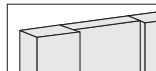

058
Noce LIGHT
canaletto
"taglio sega"



057
Abete "antico"
grigio



066
Olmo
americano
SW



067
Frassino olivato
termotrattato SW



102
Rovere tinto
affumicato
SW

LEGNO EXCLUSIVE



077
Fossil oak

Programma STANDARD

FINITURE REALIZZABILI - PIANI

TIPOLOGIE LAVABI



SOPRAPIANO
da appoggio



SOPRAPIANO
da incasso



SOTTOPIANO
da incasso



FILOPIANO
stampato

FINITURA PIANI

COLORI / ESSENZE

LAVABI

VETRO EXTRALIGHT SABBIAIO VERNICIATO - H 12 mm

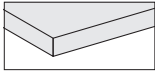

818
Bianco



816
Tortora



817
Caffè



VETRO EXTRALIGHT ACIDATO VERNICIATO - H 12 mm

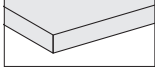

818
Bianco



816
Tortora

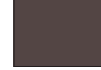

817
Caffè



CRISTALPLANT® - H 15 mm

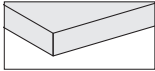

Bianco



LASERMAT - H 20 mm

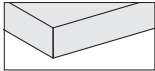

183
Bianco Kos



178
Bianco Malè

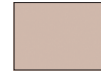

179
Beige Luxor



187
Beige Arizona

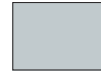

184
Grigio Efeso



181
Grigio Londra

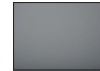

202
Grigio Antrim



185
Grigio Bromo

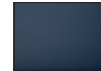

203
Blu Fes

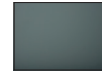

188
Verde
Comodoro



186
Cacao
Orinoco



182
Nero Ingo

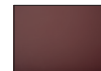

189
Rosso Jaipur



CORIAN® - H 20 mm

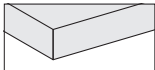

173
Bianco



PIETRA - MARMO - GRANITO - H 20 mm

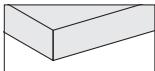

240
Marmo bianco
Carrara



250
Pietra Serena



257
Quarzite
Silver



199
Granito Nero
Assoluto
Zimbabwe

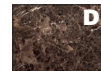

261
Marmo
Emperador
Dark

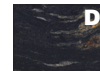

254
Granito Black
Cosmic



259
Quarzite
Calacatta



260
Marmo Grey
Stone



273
Pietra d'Avola



274
Pietra Crema
d'Orcia



266
Marmo bianco
Carrara
Lithoverde®

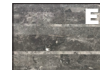

265
Marmo Gris
du Marais
Lithoverde®



267
Pietra d'Avola
Lithoverde®



COMPOSITO DEKTON® - H 20 mm

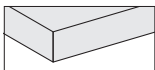

455
Beige Edora



453
Nero Sirius



454
Bianco Zenith

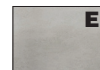

451
Grigio Strato

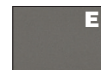

459
Marrone
Galema



461
Domoos

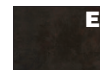

462
Keranium



460
Kelya



COMPOSITO MDI - H 12 mm

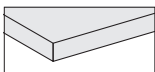

233
Bianco



234
Cammello



236
Visone



237
Grigio



238
Nero

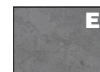

231
Devon

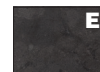

232
Surrey



Programma STANDARD

FINITURE REALIZZABILI - PIANI

TIPOLOGIE LAVABI



SOPRAPIANO
da appoggio



SOPRAPIANO
da incasso



SOTTOPIANO
da incasso



FILOPIANO
stampato

FINITURA PIANI

COLORI / ESSENZE

LAVABI

LEGNO MASSELLO - H 23 mm

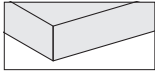

058
Noce LIGHT
canaletto
"taglio sega"



057
Abete "antico"
grigio



066
Olmo
americano
SW



067
Frassino olivato
termotrattato SW



102
Rovere tinto
affumicato
SW



Programma STANDARD

Design Piero Lissoni + C.R.S. Boffi

Wall hung, modular base/tall units. The handle use is compulsory.

Top (1)

The square-edged tops can be fitted with top-mounted, built-in, under-mounted or moulded flush-mounted washbasins.

THICKNESS: 12 - 15 - 20 - 23 mm.

DEPTH: 500 mm

Unit (2)

It's made of 19 mm thick wood particle board panels, waterproof, with low formaldehyde emission (class E1, CARB P2 / TSCA Title VI certified), treated with high performance melamine resin. Front and back edges in ABS, same colour (SIDE PANEL HEIGHT: 300 - 470 mm (both compatible with built-in / under-mounted / moulded flush-mounted Boffi washbasins).

SIDE PANEL DEPTH: 470 mm.

DEPTH INCLUDING DOOR: 495 mm.

MODULE WIDTH: 300 - 450 - 600 - 900 - 1200 mm.



Finished side panel (3)

The visible side panels of all compositions are finished, without an extra charge (please note that front panels in Corian® have finished side panels in white Ecolak and front panels in Wood 3D have finished side panels in wood veneer - without 3D effect).

The finished side panel includes the finishing of the frontal vertical edge too (Lasermat excluded).

The finished side panel IS NOT FEASIBLE in SOLID WOOD and 3D SOLID WOOD: for these finishes please order the end panels separately.

Drawers (4)

LEGRABOX series with sides and back in varnished matt black metal. Bottom in black melamine. Front of internal drawers in melamine, same finish as carcass.

Doors and front panels (5)

Finished, thickness 23 mm, with compulsory handle.

Handle (6)

Each front should have an handle, to be chosen from the range, considering the addition or not of the price increase.

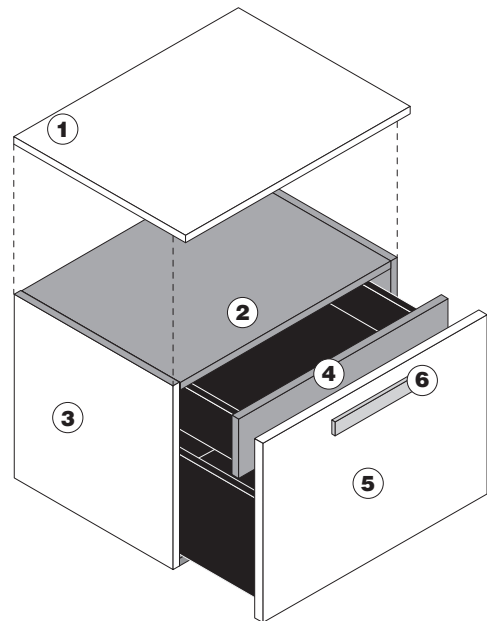

Programma STANDARD

FEASIBLE FINISHES - CABINETS

MELAMINE-COATED
CARCASS



606
Elm (open-
pore effect)

610
Thermo-
treated larch
wood (open
pore effect)

608
Grey-graphite
oak (open
pore effect)

FRONT PANELS
FINISH

COLOURS / SPECIES

EASYLAK+



506 Cortina white
507 Leeds grey

LASERMAT

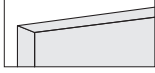

183 Kos white
178 Malè white
179 Luxor beige
187 Arizona beige
184 Efeso grey
202 Antrim grey
181 Londra grey
185 Bromo grey
203 Fes blue
188 Comodoro green



186 Orinoco cocoa
182 Ingo black
189 Jaipur red

SILCOLAK

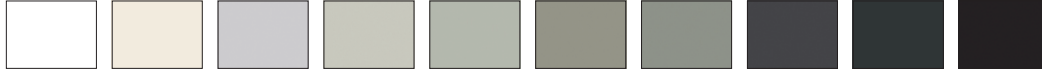

521 Siberia white
523 Oyster-pearl
524 Luton grey
525 Gravel grey
526 Hay
527 Rope-colour
528 Silt
529 Slate grey
530 Abyss black
531 Jet black

ECOLAK

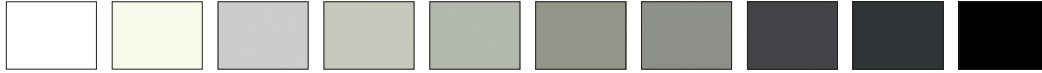
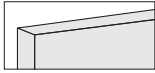

510 Arctic white
129 Magnolia
513 Cloud colour
024 Pebble grey
512 Oat colour
025 Ecrú
023 Mud
515 Basalt grey
517 Charcoal
027 Black

WOOD

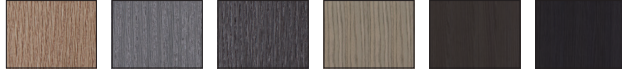

049 Oak
033 Ash-grey oak
076 Grey-graphite oak
334 Ecowood Xilo 2.0 Planked Sand (18.22)
335 Ecowood Xilo 2.0 Planked Grey (18.23)
333 Ecowood Xilo 2.0 Striped Black (18.04)

POLYESTER

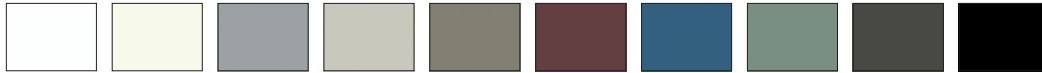
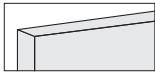

003 White
129 Magnolia
005 Grey RAL 7038
024 Pebble grey
063 Sand
107 Petra red
117 Jodhpur blue
113 Caligo green
004 Grey
027 Black

WOOD SELECTION

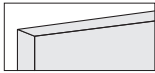

337 American elm
048 Core walnut
093 Canaletto walnut U.S.
101 Smoked oak

METALS

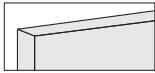

198 White
934 Aluminium
197 Zinc+
195 Vintage brass
196 Copper+
192 Titanium
191 Lead

CORIAN®

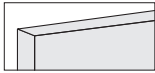

173 White

Programma STANDARD

FEASIBLE FINISHES - CABINETS

MELAMINE-COATED
CARCASS



606
Elm (open-
pore effect)



610
Thermo-
treated larch
wood (open
pore effect)



608
Grey-graphite
oak (open
pore effect)

FRONT PANELS
FINISH

COLOURS / SPECIES

WOOD 3D

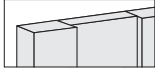

049
Oak



033
Ash-grey oak



076
Grey-graphite
oak



337
American elm



048
Core walnut



334
Ecowood Xilo
2.0 Planked
Sand (18.22)



335
Ecowood Xilo
2.0 Planked
Grey (18.23)



333
Ecowood Xilo
2.0 Striped
Black (18.04)



093
Canaletto
walnut U.S.



101
Smoked oak

SOLID WOOD

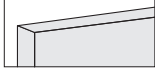

058
LIGHT Canaletto
walnut, "sawn"
effect



057
"Old" grey
pinewood



066
American elm
SW



067
Thermo-treated
Olivato ash
wood SW



102
Smoked dyed
oak SW

SOLID WOOD 3D (Price: SOLID WOOD + 10%)

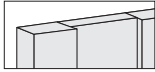

058
LIGHT Canaletto
walnut, "sawn"
effect



057
"Old" grey
pinewood



066
American elm
SW



067
Thermo-treated
Olivato ash
wood SW



102
Smoked dyed
oak SW

WOOD EXCLUSIVE

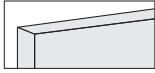

077
Fossil oak

Programma STANDARD

FEASIBLE FINISHES - TOPS

WASHBASIN
TYPOLOGIES



TOP-
MOUNTED



BUILT-IN



UNDER-
MOUNTED



moulded
FLUSH-
MOUNTED

TOPS FINISH

COLOURS / SPECIES

WASHBASINS

SANDED PAINTED EXTRALIGHT GLASS - H 12 mm

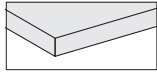

818
White



816
Dove grey



817
Coffee



FROSTED PAINTED EXTRALIGHT GLASS - H 12 mm

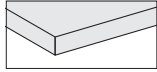

818
White



816
Dove grey

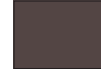

817
Coffee



CRISTALPLANT® - H 15 mm

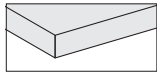

-
White



LASERMAT - H 20 mm

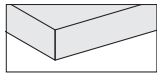

183
Kos white



178
Malè white



179
Luxor beige



187
Arizona beige



184
Efeso grey



181
Londra grey



202
Antrim grey



185
Bromo grey



203
Fes blue



188
Comodoro
green



186
Orinoco
cocoa



182
Ingo black

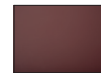

189
Jaipur red



CORIAN® - H 20 mm

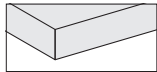

173
White



STONE - MARBLE - GRANITE - H 20 mm

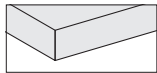

240
White Carrara
marble



250
Serena stone



257
Quartzite
Silver



199
Absolute black
Zimbabwe
granite



261
Emperador
Dark marble



254
Black Cosmic
granite



259
Quartzite
Calacatta



260
Grey Stone
marble



273
Pietra d'Avola
stone



274
Pietra Crema
d'Orcia stone



266
White Carrara
marble
Lithoverde®



265
Gris du
Marais marble
Lithoverde®



267
Pietra
d'Avola stone
Lithoverde®



DEKTON® COMPOSITE - H 20 mm

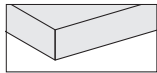

455
Edora beige



453
Sirius black



454
Zenith white



451
Strato grey



459
Galema
brown



461
Domoos



462
Keranium



460
Kelya



MDI COMPOSITE - H 12 mm

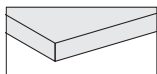

233
White



234
Camel



236
Mink



237
Grey



238
Black



231
Devon



232
Surrey



Programma STANDARD

FEASIBLE FINISHES - TOPS

WASHBASIN
TYPOLOGIES



TOP-
MOUNTED



BUILT-IN



UNDER-
MOUNTED



moulded
FLUSH-
MOUNTED

TOPS FINISH

COLOURS / SPECIES

WASHBASINS

SOLID WOOD - H 23 mm

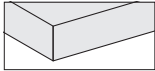

058
LIGHT Canaletto
walnut, "sawn"
effect



057
"Old" grey
pinewood



066
American elm
SW



067
Thermo-treated
Olivato ash
wood SW



102
Smoked dyed
oak SW



Programma STANDARD

Design Piero Lissoni + C.R.S. Boffi

Système modulaire de bases / armoires suspendues. Poignée obligatoire.

Plan (1)

Plan avec chant droit aménageable avec lavabos sur plan d'appui, sur plan à encastrer, sous plan à encastrer ou affleurants moulés.

ÉPAISSEUR: 12 - 15 - 20 - 23 mm.

PROFONDEUR: 500 mm.

Caisson (2)

Réalisé en panneaux de particules de bois d'épaisseur 19 mm, hydrofuges, à faible teneur en formaldéhyde (certifié classe E1 / CARB P2 / TSCA Title VI) mélaminé avec papiers à haute densité traités avec des résines mélaminiques. Chant avant et arrière en ABS de la même couleur.

HAUTEUR CÔTÉ: 300 - 470 mm (les deux compatibles avec lavabos Boffi sur plan à encastrer / sous plan à encastrer/ affleurants moulés).

PROFONDEUR CÔTÉ: 470 mm.

PROFONDEUR AVEC FAÇADE: 495 mm.

LARGEUR MODULE: 300 - 450 - 600 - 900 - 1200 mm.

Côté selon finitions disponibles (3)

Sur chaque composition sont réalisés, sans majoration de prix, les côtés d'extrémité selon les finitions disponibles (considérer que pour les meubles avec façades en Corian® le côté fini sera en Ecolak blanc / pour meubles avec façades en Bois 3D le côté sera en bois plaqué lisse, sans lattes juxtaposées des différentes épaisseurs).

Le côté fini comprend également la finition du chant vertical apparent (sauf Lasserat).

Le côté fini N'EST PAS réalisable en BOIS MASSIF et BOIS MASSIF 3D: pour ces finitions il est nécessaire de commander séparément les panneaux d'extrémité.

Tiroirs (4)

Système LEGRABOX, avec rebords latéraux et arrière en métal peint en couleur noir mat. Fond en mélaminé noir. Façades tiroirs internes en mélaminé finition caisson.

Portes et façades (5)

Réalisées selon les finitions disponibles, épaisseur 23 mm, poignée obligatoire.

Poignée (6)

Chaque façade doit être munie de poignée, au choix parmi celles de la gamme, sans ou avec majoration de prix.

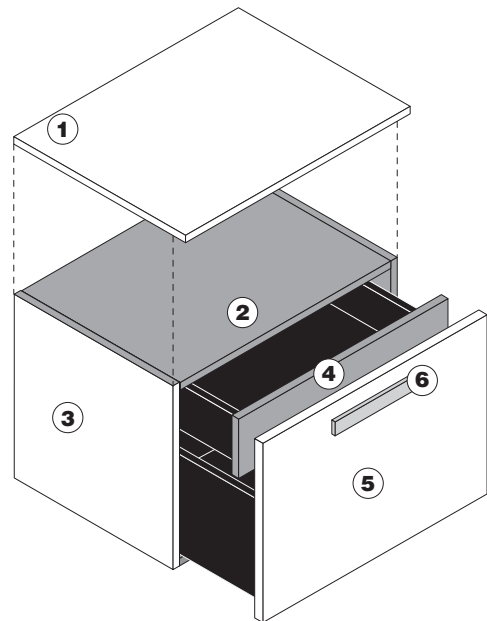

Programma STANDARD

FINITIONS RÉALISABLES - MEUBLES

CAISSON MÉLAMINÉ



606
Orme (effet
pores
ouverts)

610
Mélèze
thermique
(effet pores
ouverts)

608
Chêne
graphite
(effet pores
ouverts)

FINITION FAÇADES COULEURS / ESSENCES

EASYLAK+

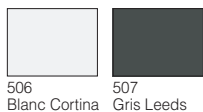
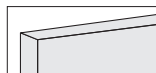

506
Blanc Cortina

507
Gris Leeds

LASERMAT

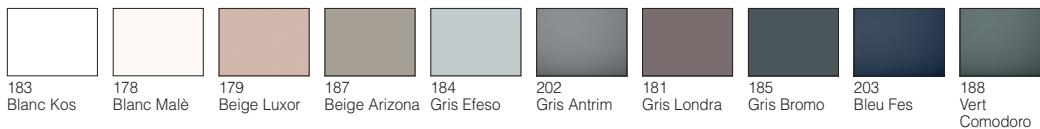
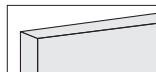

183
Blanc Kos

178
Blanc Malè

179
Beige Luxor

187
Beige Arizona

184
Gris Efeso

202
Gris Antrim

181
Gris Londra

185
Gris Bromo

203
Bleu Fes

188
Vert
Comodoro

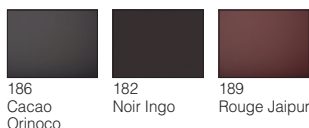

186
Cacao
Orinoco

182
Noir Ingo

189
Rouge Jaipur

SILCOLAK

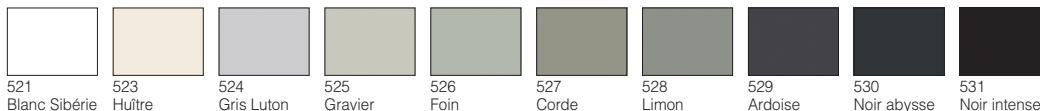

521
Blanc Sibérie

523
Huître

524
Gris Luton

525
Gravier

526
Foin

527
Corde

528
Limon

529
Ardoise

530
Noir abysses

531
Noir intense

ECOLAK

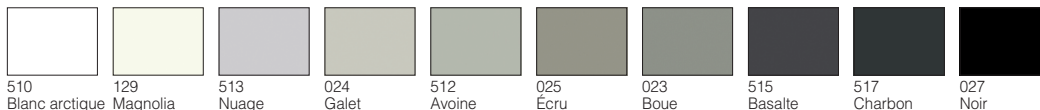
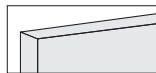

510
Blanc arctique

129
Magnolia

513
Nuage

024
Galet

512
Avoine

025
Écru

023
Boue

515
Basalte

517
Charbon

027
Noir

BOIS

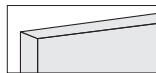

049
Chêne

033
Chêne cendré
gris

076
Chêne
graphite

334
Ecowood Xilo
2.0 Planked
Sand (18.22)

335
Ecowood Xilo
2.0 Planked
Grey (18.23)

333
Ecowood Xilo
2.0 Striped
Black (18.04)

POLYESTER

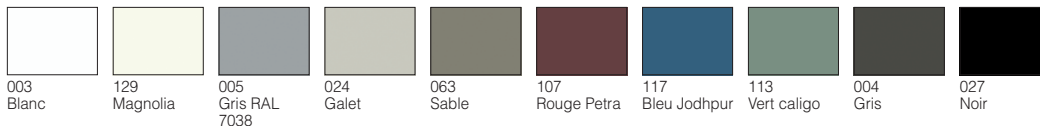

003
Blanc

129
Magnolia

005
Gris RAL
7038

024
Galet

063
Sable

107
Rouge Petra

117
Bleu Jodhpur

113
Vert caligo

004
Gris

027
Noir

BOIS SELECTION

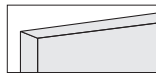

337
Orme
Américain

048
Cœur de
noyer

093
Noyer
"canaletto"
U.S.

101
Chêne fumé

METALS



198
Blanc

934
Aluminium

197
Zinc+

195
Laiton Vintage

196
Cuivre+

192
Titane

191
Plomb

CORIAN®



173
Blanc

Programma STANDARD

FINITIONS RÉALISABLES - MEUBLES

CAISSON MÉLAMINÉ



606
Orme (effet
pores
ouverts)

610
Mélèze
thermique
(effet pores
ouverts)

608
Chêne
graphite
(effet pores
ouverts)

FINITION FAÇADES COULEURS / ESSENCES

BOIS 3D

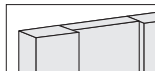

049
Chêne



033
Chêne cendré
gris



076
Chêne
graphite



337
Orme
Américain



048
Cœur de
noyer



334
Ecowood Xilo
2.0 Planked
Sand (18.22)



335
Ecowood Xilo
2.0 Planked
Grey (18.23)



333
Ecowood Xilo
2.0 Striped
Black (18.04)



093
Noyer
"canaletto"
U.S.



101
Chêne fumé

BOIS MASSIF



058
Noyer LIGHT
canaletto
"effet scié"



057
Sapin
"antique" gris



066
Orme
Américain SW



067
Frêne olivier
thermotraité SW



102
Chêne teinté
fumé SW

BOIS MASSIF 3D (Prix: BOIS MASSIF + 10%)

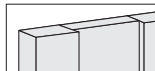

058
Noyer LIGHT
canaletto
"effet scié"



057
Sapin
"antique" gris



066
Orme
Américain SW



067
Frêne olivier
thermotraité SW



102
Chêne teinté
fumé SW

BOIS EXCLUSIVE



077
Fossil oak

Programma STANDARD

FINITIONS RÉALISABLES - PLANS

TYPOLOGIES LAVABOS



SUR PLAN
d'appui



SUR PLAN à
encastrer



SOUS PLAN
à encastrer



AFFLEURANT
moulé

FINITION PLANS

COULEURS / ESSENCES

LAVABOS

VERRE EXTRALIGHT SABLÉ PEINT - H 12 mm

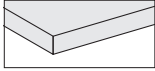

818
Blanc



816
Gris
tourterelle



817
Café



VERRE EXTRALIGHT ACIDIFIÉ PEINT - H 12 mm

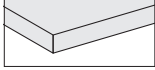

818
Blanc



816
Gris
tourterelle



817
Café



CRISTALPLANT® - H 15 mm

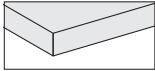

Blanc



LASERMAT - H 20 mm

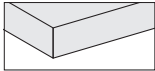

183
Blanc Kos



178
Blanc Malé



179
Beige Luxor



187
Beige Arizona



184
Gris Efeso



181
Gris Londra



202
Gris Antrim



185
Gris Bromo



203
Bleu Fes



188
Vert
Comodoro



186
Cacao
Orinoco



182
Noir Ingo



189
Rouge Jaipur



CORIAN® - H 20 mm

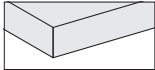

173
Blanc



PIERRE - MARBRE - GRANITE - H 20 mm

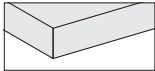

240
Marbre blanc
Carrara



250
Pierre Serena



257
Quartzite
Silver



199
Granite
Noir Absolu
Zimbabwe



261
Marbre
Emperador
Dark



254
Granite Black
Cosmic



259
Quartzite
Calacatta



260
Marbre Grey
Stone



273
Pietra d'Avola



274
Pierre Crema
d'Orcia



266
Marbre blanc
Carrara
Lithoverde®



265
Marbre Gris
du Marais
Lithoverde®



267
Pietra d'Avola
Lithoverde®



COMPOSITE DEKTON® - H 20 mm

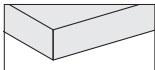

455
Beige Edora



453
Noir Sirius



454
Blanc Zenith



451
Gris Strato



459
Marron
Galema



461
Domoos



462
Keranium



460
Kelya



COMPOSITE MDI - H 12 mm

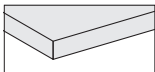

233
Blanc



234
Chameau



236
Vison



237
Gris



238
Noir



231
Devon



232
Surrey



Programma STANDARD

FINITIONS RÉALISABLES - PLANS

TIPOLOGIES LAVABOS



SUR PLAN
d'appui



SUR PLAN à
encastrer



SOUS PLAN
à encastrer



AFFLEURANT
moulé

FINITION PLANS

COULEURS / ESSENCES

LAVABOS

BOIS MASSIF - H 23 mm

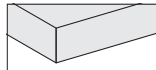

058
Noyer LIGHT
canaletto
"effet scié"



057
Sapin
"antique" gris



066
Orme
Américain SW



067
Frêne olivier
thermotraité SW



102
Chêne teinté
fumé SW



Programma STANDARD

Design Piero Lissoni + C.R.S. Boffi

Modulares System aus Hänge-Unter-/ Hochschränken. Griffe sind erforderlich.

Waschtischplatte (1)

Rechteckige Waschtischplatte für Aufsatz-, Einbau- von oben, Unterbau-oder flächenbündiges formgepresstes Waschbecken.

STÄRKE: 12 -15 - 20 - 23 mm.

TIEFE: 500 mm

Schrank (2)

Aus Paneelen aus Spanplatte, Stärke 19 mm, wasserabweisend, mit geringem Formaldehydgehalt (zertifiziert Klasse E1, CARB P2 / TSCA Title VI), mit Melaminharzbeschichtung mit hoher Dichte. Vordere und rückseitige Kante aus ABS in Ausführung.

SEITENTEIL HÖHE: 300 - 470 mm (beide sind kompatibel mit Einbaubecken von oben / Unterbaubecken / flächenbündigen formgepressten Waschbecken Boffi).

SEITENTEIL TIEFE: 470 mm.

TIEFE MIT FRONTPANEEL: 495 mm.

ELEMENTENBREITE: 300 - 450 - 600 - 900 - 1200 mm.

Seitenteil in Ausführung (3)

An jeder Komposition werden ohne Aufpreis die externen Abschluss-Seitenteile in Ausführung gefertigt (bei Elementen mit Frontpaneelen in Corian® ist das Seitenteil in Ausführung in Ecolak weiß, bei Elementen mit Frontpaneelen in Holz 3D ist das Seitenteil glatt furniert, ohne Leisteneffekt).

Das Seitenteil in Ausführung umfasst auch die Ausführung der sichtbaren vertikalen Vorderkante (außer Lasermat).

Das Seitenteil in Ausführung ist NICHT erhältlich in MASSIVHOLZ und MASSIVHOLZ 3D: Bei diesen Ausführungen sind die Abschlusspaneelle getrennt zu bestellen.

Schublade (4)

System LEGRABOX mit seitlichen und rückseitigen Blenden aus mattschwarz lackiertem Metall. Boden schwarze Melaminbeschichtung. Frontpaneel der Innenschublade in melaminbeschichteter Ausführung wie Schrankelement.

Türen und Frontpaneele (5)

In Ausführung, Stärke 23 mm, Griff erforderlich.

Griff (6)

Jedes Frontpaneel muss mit Griffen ausgerüstet werden. Auswahl unter den Mustern, mit oder ohne Aufpreis.

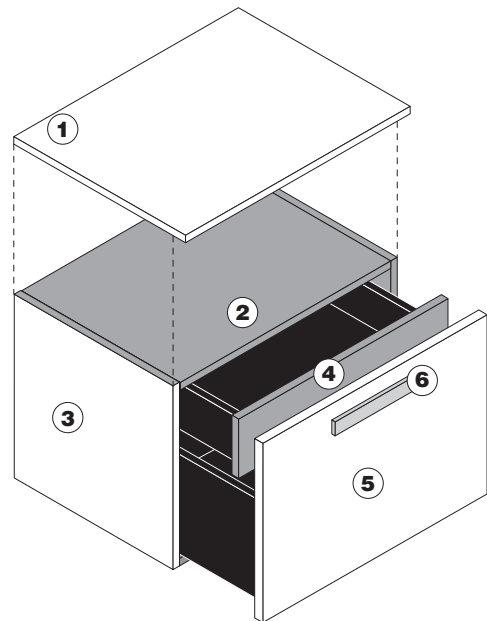

Programma STANDARD

ERHÄLTICHE AUSFÜHRUNGEN - ELEMENTE

MELAMINBESCHICHTETES
SCHRANKELEMENT



606
Ulme (Effekt
offenporig)



610
Thermoholz
Lärche (Effekt
offenporig)



608
Eiche
grafitgrau
(Effekt
offenporig)

AUSFÜHRUNG FRONTEN

FARBEN / HOLZARTEN

EASYLAK+



506
Weiß Cortina



507
Grau Leeds

LASERMAT

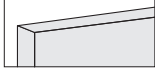

183
Weiß Kos



178
Weiß Kos



179
Beige Luxor



187
Beige Arizona



184
Grau Efeso



202
Grau Antrim



181
Grau Londra



185
Grau Bromo



203
Blue Fes



188
Grün
Comodoro



186
Kakao
Orinoco



182
Schwarz Ingo



189
Rot Jaipur

SILCOLAK

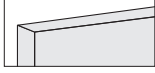

521
Weiß Sibirien



523
Perlweiß



524
Grau Luton



525
Grau Schotter



526
Heu



527
Naturfarben



528
Schlamm



529
Ardoise



530
Völlig schwarz



531
Tiefschwarz

ECOLAK

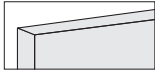

510
Arktischweiß



129
Magnolie



513
Wolkenfarben



024
Kieselgrau



512
Haferfarben



025
Ekrü



023
Lehm Braun



515
Basaltgrau



517
Kohlschwarz



027
Schwarz

HOLZ



049
Eiche



033
Eiche
Aschgrau



076
Eiche
Grafitgrau



334
Ecowood Xilo
2.0 Planked
Sand (18.22)



335
Ecowood Xilo
2.0 Planked
Grey (18.23)



333
Ecowood Xilo
2.0 Striped
Black (18.04)

POLYESTER

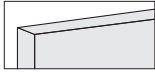

003
Weiß



129
Magnolie



005
Grau RAL
7038



024
Kieselgrau



063
Sandfarben



107
Rot Petra



117
Blue Jodhpur



113
Grün caligo



004
Grau



027
Schwarz

HOLZ SELECTION

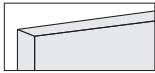

337
Amerikanische
Ulme



048
Kern-
Nussbaum



093
Nussbaum
Canaletto
U.S.



101
Rächereiche

METALS

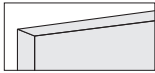

198
Weiß



934
Aluminium



197
Zink+



195
Messing
Vintage



196
Kupfer+



192
Titan



191
Blei

CORIAN®



173
Weiß

Programma STANDARD

ERHÄLTICHE AUSFÜHRUNGEN - ELEMENTE

MELAMINBESCHICHTETES
SCHRANKELEMENT

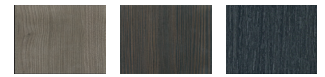

606
Ulme (Effekt
offenporig)

610
Thermoholz
Lärche (Effekt
offenporig)

608
Eiche
grafitgrau
(Effekt
offenporig)

AUSFÜHRUNG
FRONTEN

FARBEN / HOLZART

TEN

HOLZ 3D

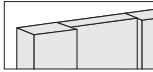

049
Eiche



033
Eiche
Aschgrau



076
Eiche
Grafitgrau



337
Amerikanische
Ulme



048
Kern-
Nussbaum



334
Ecowood Xilo
2.0 Planked
Sand (18.22)



335
Ecowood Xilo
2.0 Planked
Grey (18.23)



333
Ecowood Xilo
2.0 Striped
Black (18.04)



093
Nussbaum
Canaletto
U.S.



101
Räuchereiche

MASSIVHOLZ

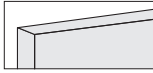

056
Nussbaum LIGHT Canaletto
Sägeschnitt



057
„Antikes“
Tannenholz
grau



066
Amerikanische
Ulme SW



067
Thermo-
Olivesche SW



102
Räuchereiche
gebeizt SW

MASSIVHOLZ 3D (Preis: MASSIVHOLZ + 10%)

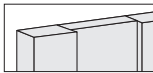

056
Nussbaum LIGHT Canaletto
Sägeschnitt



057
„Antikes“
Tannenholz
grau



066
Amerikanische
Ulme SW



067
Thermo-
Olivesche SW



102
Räuchereiche
gebeizt SW

HOLZ EXCLUSIVE

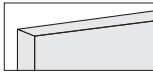

077
Fossil oak



AUFSATZBECKEN



EINBAUBECKEN
von oben



UNTERBAUBECKEN



FLÄCHENBÜNDIG
formgepresst

AUSFÜHRUNG

WASCHTISCHPLATTEN FARBEN / HOLZARTEN

WASCHBECKEN

GLAS SANDBESTRAHLTES EXTRALIGHT LACKIERT - H 12 mm

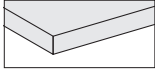

818
Weiß



816
Taubengrau



817
Kaffee



GLAS GEÄTZT EXTRALIGHT LACKIERT - H 12 mm

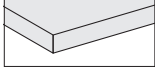

818
Weiß



816
Taubengrau



817
Kaffee



CRISTALPLANT® - H 15 mm

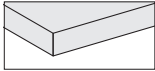

Weiß



LASERMAT - H 20 mm

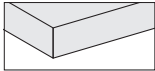

183
Weiß Kos



178
Weiß Kos



179
Beige Luxor



187
Beige Arizona



184
Grau Efeso



181
Grau Londra



202
Grau Antrim



185
Grau Bromo



203
Blue Fes



188
Grün
Comodoro



186
Kakao
Orinoco



182
Schwarz
Ingo



189
Rot Jaipur



CORIAN® - H 20 mm

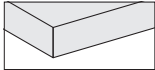

173
Weiß



STEIN - MARMOR - GRANIT - H 20 mm

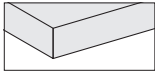

240
Carrara-
Marmor weiß



250
Stein
Serena



257
Quarzit
Silver



199
Granit
Tiefschwarz
Zimbabwe



261
Marmor
Emperador
Dark



254
Granit Black
Cosmic



259
Quarzit
Calacatta



260
Marmor
Grey
Stone



273
Stein Pietra
D'Avola



274
Stein Crema
d'Orcia



266
Marmor
weiß Carrara
Lithoverde®



265
Marmor Gris
du Marais
Lithoverde®



267
Stein Pietra
D'Avola
Lithoverde®



AGGLOMERAT DEKTON® - H 20 mm

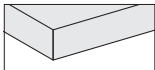

455
Beige Edora



453
Schwarz
Sirius



454
Weiß
Zenith



451
Grau
Strato



459
Braun
Galema



461
Domoos



462
Keranium



460
Kelya



AGGLOMERAT MDI - H 12 mm

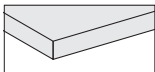

233
Weiß



234
Kamel



236
Nerz



237
Grau



238
Schwarz



231
Devon



232
Surrey



Programma STANDARD

ERHÄLTICHE AUSFÜHRUNGEN - WASCHTISCHPLATTEN

WASCHBECKENARTEN



AUFSATZBECKEN



EINBAUBECKEN
von oben



UNTERBAUBECKEN



FLÄCHENBÜNDIG
formgepresst

AUSFÜHRUNG

WASCHTISCHPLATTEN FARBEN / HOLZARTEN

WASCHBECKEN

MASSIVHOLZ - H 23 mm

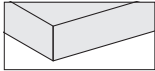

056
Nussbaum LIGHT Caraleto
Sägeschnitt



057
„Antikes“
Tannenholz
grau



066
Amerikanische
Ulme SW



067
Thermo-
Olivesche SW



102
Räuchereiche
gebeizt SW



Programma STANDARD

Design Piero Lissoni + C.R.S. Boffi

Sistema modular de muebles contenedores bajo / columna suspendidos. Tirador obligatorio.

Encimera (1)

Encimera en ángulo recto que se puede equipar con lavabos sobre encimera apoyados, sobre encimera empotrados, bajo encimera empotrados y enrasados a la encimera moldeados.

GROSOR: 12 - 15 - 20 - 23 mm.

PROFUNDIDAD: 500 mm.

Contenedor (2)

Realizados en paneles de partículas de madera grosor 19 mm, hidrófugos, con bajo contenido de formaldehído (certificado clase E1, CARB P2/ TSCA Title VI) melamínico con papeles con alto gramaje tratados con resinas melamínicas. Borde delantero y trasero en ABS del mismo color.

ALTURA COSTADO: 300 - 470 mm (ambas compatibles con lavabos Boffi sobre encimera empotrados / bajo encimera empotrados / enrasados a la encimera moldeados).

PROFUNDIDAD COSTADO: 470 mm.

PROFUNDIDAD CON FRENTE: 495 mm.

ANCHURA MÓDULO: 300 - 450 - 600 - 900 - 1200 mm.

Lateral en acabado (3)

En cada composición se realizan, sin incremento de precio, los costados externos terminales en acabado (hay que considerar que para los muebles con frentes de Corian® el costado acabado será de Ecolak blanco / para muebles con frentes de Madera 3D el costado acabado será chapado liso, sin efecto-alistonado).

El costado en acabado también incluye el acabado del borde vertical a la vista (excepto Lasermat).

El costado en acabado NO es realizable en MADERA MACIZA y MADERA MACIZA 3D: para estos acabados es necesario solicitar por separado los paneles terminales.

Cajones (4)

Sistema LEGRABOX, con laterales y trasera de metal pintado en color negro mate. Fondo de madera ennoblecida negra. Frente cajones internos en madera ennoblecida acabado mueble contenedor.

Puertas y frentes (5)

Realizadas en acabado, 23 mm de grosor, tirador obligatorio.

Tirador (6)

Cada frente debe estar equipado con tirador, a elegir entre los de la gama, sin o con incremento de precio.

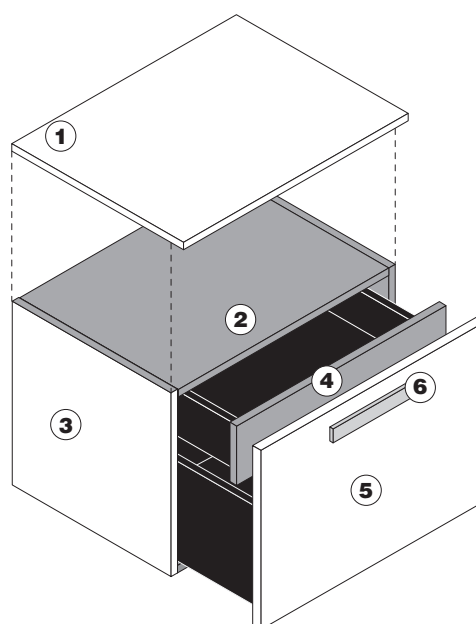

Programma STANDARD

ACABADOS REALIZABLES - MUEBLES

MUEBLE
CONTENEDOR
ENNOBLECIDO.



606
Olmo (efecto
poro abierto)



610
Alerce
térmico
(efecto poro
abierto)



608
Roble grafito
(efecto poro
abierto)

ACABADO
FRENTE

COLORES / MADERAS

EASYLAK+



506
Blanco
Cortina



507
Gris Leeds

LASERMAT

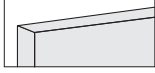

183
Blanco Kos



178
Blanco Malè



179
Beige Luxor



187
Beige Arizona



184
Gris Efeso



202
Gris Antrim



181
Gris Londra



185
Gris Bromo



203
Azul Fes



188
Verde
Comodoro



186
Cacao
Orinoco



182
Negro Ingo



189
Rojo Jaipur

SILCOLAK

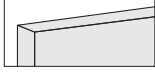

521
Blanco
Siberia



523
Ostra



524
Gris Luton



525
Grava



526
Heno



527
Cuerda



528
Limo



529
Pizarra



530
Negro Abismo



531
Negro Intenso

ECOLAK

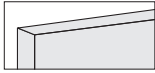

510
Blanco ártico



129
Magnolia



513
Nube



024
Guijarro



512
Avena



025
Crudo



023
Fango



515
Basalto



517
Carbón



027
Negro

MADERA



049
Roble



033
Roble ceniza



076
Roble grafito



334
Ecowood Xilo
2.0 Planked
Sand (18.22)



335
Ecowood Xilo
2.0 Planked
Grey (18.23)



333
Ecowood Xilo
2.0 Striped
Black (18.04)

POLIÉSTER

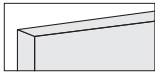

003
Blanco



129
Magnolia



005
Gris RAL
7038



024
Guijarro



063
Arena



107
Rojo Petra



117
Azul Jodhpur



113
Verde caligo



004
Gris



027
Negro

MADERA SELECTION

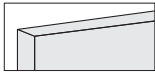

337
Olmo
americano



048
Alma de
nogal



093
Nogal canaletto
(americano)
U.S.



101
Roble
ahumado

METALS

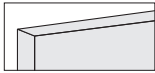

198
Blanco



934
Aluminium



197
Zink+



195
Latón Vintage



196
Cobre+



192
Titanio



191
Plomo

CORIAN®



173
Blanco

Programma STANDARD

ACABADOS REALIZABLES - MUEBLES

MUEBLE
CONTENEDOR
ENNOBLECIDO.



606
Olmo (efecto
poro abierto)

610
Alerce
térnico
(efecto poro
abierto)

608
Roble grafito
(efecto poro
abierto)

ACABADO
FRENTE

COLORES / MADERAS

MADERA 3D

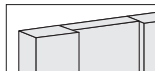

049
Roble



033
Roble ceniza



076
Roble grafito



337
Olmo
americano



048
Alma de
nogal



334
Ecowood Xilo
2.0 Planked
Sand (18.22)



335
Ecowood Xilo
2.0 Planked
Grey (18.23)



333
Ecowood Xilo
2.0 Striped
Black (18.04)



093
Nogal canaletto
(americano)
U.S.



101
Roble
ahumado

MADERA MACIZA



058
Nogal LIGHT
canaletto
"corte sierra"



057
Abeto
"antiguo" gris



066
Olmo
americano
SW



067
Fresno Olivato
termotratado SW



102
Roble teñido
ahumado SW

MADERA MACIZA 3D (Precio: MADERA MACIZA + 10%)

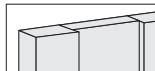

058
Nogal LIGHT
canaletto
"corte sierra"



057
Abeto
"antiguo" gris



066
Olmo
americano
SW



067
Fresno Olivato
termotratado SW



102
Roble teñido
ahumado SW

MADERA EXCLUSIVE



077
Fossil oak

Programma STANDARD

ACABADOS REALIZABLES - ENCIMERAS

TIPOS LAVABOS



SOBRE
ENCIMERA
apoyado



SOBRE
ENCIMERA
empotrado



BAJO
ENCIMERA
empotrado



ENRASADO
A LA
ENCIMERA
moldeado

ACABADO
ENCIMERAS

COLORES / MADERAS

LAVABOS

VIDRIO EXTRALIGHT ARENADO LACADO - H 12 mm

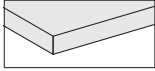

818
Blanco



816
Tortola



817
Café



VIDRIO EXTRALIGHT ACIDADO LACADO - H 12 mm

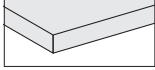

818
Blanco



816
Tortola

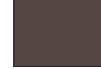

817
Café



CRISTALPLANT® - H 15 mm

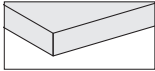

Blanco



LASERMAT - H 20 mm

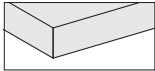

183
Blanco Kos



178
Blanco Malè

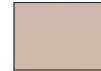

179
Beige Luxor



187
Beige Arizona



184
Gris Efeso



181
Gris Londra

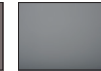

202
Gris Antrim



185
Gris Bromo

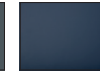

203
Azul Fes

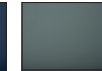

188
Verde
Comodoro



186
Cacao
Orinoco



182
Negro Ingo

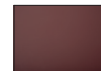

189
Rojo Jaipur



CORIAN® - H 20 mm

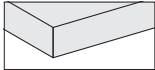

173
Blanco



PIEDRA - MÁRMOL - GRANITO - H 20 mm

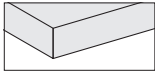

240
Mármol
blanco
Carrara



250
Piedra
Serena



257
Cuarcita
Silver



199
Granito Negro
Absoluto
Zimbabwe

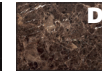

261
Mármol
Emperador
Dark

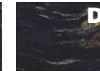

254
Granito Black
Cosmic



259
Cuarcita
Calacatta



260
Mármol Grey
Stone



273
Pietra d'Avola



274
Piedra Crema
d'Orcia



266
Mármol blanco
Carrara
Lithoverde®

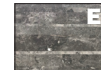

265
Mármol Gris
du Marais
Lithoverde®



267
Pietra d'Avola
Lithoverde®



COMPUESTO DEKTON® - H 20 mm

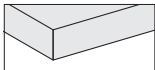

455
Beige Edora



453
Negro Sirius



454
Blanco Zenith



451
Gris Strato



459
Marrón
Galema



461
Domoos

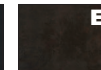

462
Keranium

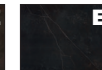

460
Kelya



COMPUESTO MDI - H 12 mm

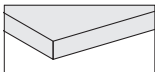

233
Blanco



234
Camello



236
Visón



237
Gris



238
Negro



231
Devon



232
Surrey



Programma STANDARD

ACABADOS REALIZABLES - ENCIMERAS

TIPOS LAVABOS



SOBRE
ENCIMERA
apoyado



SOBRE
ENCIMERA
empotrado



BAJO
ENCIMERA
empotrado



ENRASADO
A LA
ENCIMERA
moldeado

ACABADO
ENCIMERAS

COLORES / MADERAS

LAVABOS

MADERA MACIZA - H 23 mm

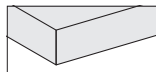

058
Nogal LIGHT
canaletto
"corte sierra"



057
Abeto
"antiguo" gris



066
Olmo
americano
SW



067
Fresno Olivato
termotratado SW



102
Roble teñido
ahumado SW

